

2016

Tabu Search Energy Optimization of Optical Grid Networks

Jay Raichandani
University of Windsor

Follow this and additional works at: <https://scholar.uwindsor.ca/etd>

Recommended Citation

Raichandani, Jay, "Tabu Search Energy Optimization of Optical Grid Networks" (2016). *Electronic Theses and Dissertations*. 5761.
<https://scholar.uwindsor.ca/etd/5761>

This online database contains the full-text of PhD dissertations and Masters' theses of University of Windsor students from 1954 forward. These documents are made available for personal study and research purposes only, in accordance with the Canadian Copyright Act and the Creative Commons license—CC BY-NC-ND (Attribution, Non-Commercial, No Derivative Works). Under this license, works must always be attributed to the copyright holder (original author), cannot be used for any commercial purposes, and may not be altered. Any other use would require the permission of the copyright holder. Students may inquire about withdrawing their dissertation and/or thesis from this database. For additional inquiries, please contact the repository administrator via email (scholarship@uwindsor.ca) or by telephone at 519-253-3000ext. 3208.

Tabu Search Energy Optimization of Optical Grid Networks

By

Jay Raichandani

A Thesis

Submitted to the Faculty of Graduate Studies

Through the School of Computer Science

In Partial Fulfillment of the Requirements for

The Degree of Master of Science at the

University of Windsor

Windsor, Ontario, Canada

2016

© 2016 Jay Raichandani

Tabu Search Energy Optimization of Optical Grid Networks

By

Jay Raichandani

APPROVED BY:

Dr. Jagdish Pathak, External Reader

Odette School of Business

Dr. Stephanos Mavromoustakos, Internal Reader

School of Computer Science

Dr. Arunita Jaekel, Advisor

School of Computer Science

May 5, 2016

DECLARATION OF ORIGINALITY

I hereby certify that I am the sole author of this thesis and that no part of this thesis has been published or submitted for publication.

I certify that, to the best of my knowledge, my thesis does not infringe upon anyone's copyright nor violate any proprietary and that any ideas, techniques, quotations, or any other material from the work of other people included in my thesis, published or otherwise, are fully acknowledged in accordance with the standard referencing practices. Furthermore, to the extent that I have included copyrighted material that surpasses the bounds of fair dealing within the meaning of the Canada Copyright Act, I certify that I have obtained written permission from the copyright owner(s) to include such material(s) in my thesis and have included copies of such copyright clearances to my appendix.

I declare that this is a true copy of my thesis, including any final revisions, as approved by my thesis committee and the Graduate Studies office, and that this thesis has not been submitted for a higher degree to any other University or Institution.

ABSTRACT

The exponential growth in the Information and Communication Technology (ICT) sector has resulted in increased power consumption and there is growing *recognition* of the need to develop more energy efficient networks. It has been shown in the literature that energy aware routing schemes for wavelength division multiplexing (WDM) optical networks can significantly reduce the overall energy consumption on the network. Much of the recent work has concentrated on switching off the unused network components during low utilization periods. In this thesis, we present a comprehensive heuristic algorithm that performs routing and wavelength assignment (RWA) and minimizes the overall energy consumption of a set of static lightpath demands, using Tabu search principle. We consider both unicast and anycast traffic models and investigate whether the additional flexibility of anycast routing can be exploited to further reduce network energy consumption.

*Dedicated to my parents Rajesh and Swati Raichandani,
and my brother Aakash Raichandani.*

ACKNOWLEDGEMENT

This thesis owes its experience to the help, support and inspiration of several people. Firstly, I would like to express my sincere appreciation and gratitude to Dr. Arunita Jaekel for her guidance during my research. Her support and inspiring suggestions have been precious for the development of this thesis content.

I would also like to thank my thesis committee members Dr. Jagdish Pathak and Dr. Stephanos Mavromoustakos for their valuable comments and suggestions for writing this thesis. In addition, entire computer science faculty members, graduate secretary and technical support staff deserves a special thanks for all the support they provided throughout my graduation.

A special thanks goes to Saja Al Mamoori, she has been the fundamental support throughout my work.

Finally, my deepest gratitude goes to my family for their unflagging love and unconditional support throughout my life and my studies. You made me live the most unique, magic and carefree childhood that has made me who I am now!

TABLE OF CONTENTS

DECLARATION OF ORIGINALITY	iii
ABSTRACT	iv
DEDICATION	v
ACKNOWLEDGEMENTS	vi
LIST OF TABLES	ix
LIST OF FIGURES.....	x
LIST OF ABBREVIATIONS/SYMBOLS	xii
1. Introduction.....	1
1.1 Overview	1
1.2 Motivation	1
1.3 Problem statement and solution outline	2
1.4 Thesis organization.....	3
2. Optical Networks	5
2.1 Introduction to optical networks.....	5
2.1.1 Optical Fiber	5
2.1.2 Ligthpath	7
2.1.3 Physical and Logical topologies	8
2.1.4 Wavelength Division Multiplexing (WDM).....	10
2.1.5 Routing and Wavelength Assignment (RWA)	12
2.2 Energy consuming devices	13
2.3 Optical Grid.....	15
2.3.1. Unicast Routing	16
2.3.2 Anycast Routing.....	17
2.4 Tabu Search	19
2.4.1 Search Space and neighborhood structure	19
2.4.2 Tabus.....	19
2.4.3 Aspiration Criteria	20
2.4.4 Termination Criteria.....	20
2.4.5 A simple Tabu search algorithm	20
2.5 Literature review	22

2.5.1 Summary of literature review	25
3. Energy aware routing in optical networks	26
3.1 Introduction	26
3.2 Network energy model	26
3.3 Solution approach	28
3.4 Proposed Tabu search algorithm	33
4. Experiments and Results	39
4.1 Simulation and Setup	39
4.1.1 Network Topology	39
4.1.2 Algorithm Inputs	40
4.2 Comparison of Tabu search heuristic	42
4.2.1 Comparison of energy consumption and number of nodes	43
4.2.2 Comparison of energy consumption and demand size	45
4.2.2 Comparison of path-length and demand size	47
5. Conclusion and Future work	49
5.1 Conclusion	49
5.2 Future work	50
Bibliography/References	51
VITA AUCTORIS	55

LIST OF TABLES

Table 2.1 Literature Review Summary	25
Table 3.1 Power Consumption of network devices	28
Table 3.2 Power consumption for RWA for considered network	31
Table 3.3 Potential paths for demands	35

LIST OF FIGURES

Figure 2.1 Cross-section of Optical Fiber.....	6
Figure 2.2 Total Internal Reflection.....	7
Figure 2.3 Lightpath setup in 5 node network	8
Figure 2.4 Physical Topology	9
Figure 2.5 Logical Topology	10
Figure 2.6 Wavelength Division Multiplexing	11
Figure 2.7 Routing and Wavelength Assignment	13
Figure 2.8 Transceiver	14
Figure 2.9 Optical Cross-Connect Switch	15
Figure 2.10 Optical Grid.....	16
Figure 2.11 Unicast Routing.....	17
Figure 2.12 Anycast Routing	18
Figure 3.1 Network Energy Model: Transparent IP-over-WDM network architecture	27
Figure 3.2 6-node network physical topology	29
Figure 3.3 6-node network with in-efficient route.....	30
Figure 3.4 6-node network with efficient routing scheme	32
Figure 3.5 Overview of Energy-Aware Tabu Search Heuristic Algorithm	33
Figure 3.6 Edge information for 6-node network	34
Figure 3.7 6-node network with 5 demands.....	35
Figure 3.8 Initial solution.....	36
Figure 3.9 Global best solution	37

Figure 3.10 Efficient routing scheme for 6-node network	37
Figure 3.11 Flowchart for Energy Aware Tabu Search Heuristic algorithm	38
Figure 4.1 COST-239 11-node network topology	41
Figure 4.2 NSFNET 14-node network topology.....	41
Figure 4.3 USANET 24-node network topology.....	42
Figure 4.4 Comparison of energy comparison for 20 demands.....	43
Figure 4.5 Comparison of energy comparison for 40 demands.....	44
Figure 4.6 Comparison of energy comparison for 200 demands.....	44
Figure 4.7 Comparison of energy comparison for 11-node network.....	45
Figure 4.8 Comparison of energy comparison for 14-node network.....	46
Figure 4.9 Comparison of energy comparison for 24-node network.....	46
Figure 4.10 Comparison of path-length for 11-node network	47
Figure 4.11 Comparison of path-length for 14-node network	48
Figure 4.12 Comparison of path-length for 24-node network	48

LIST OF ABBREVIATIONS/SYMBOLS

- ILP – Integer Linear Programming
- RWA – Routing and Wavelength Assignment
- WDM – Wavelength Division Multiplexing
- LP - Lightpath
- EOE – Electrical to Optical to Electrical
- IP –Internet Protocol
- LAN – Local Area Network
- MAN – Metropolitan Area Network
- WAN – Wide Area Network
- Gbps – Giga bits per second
- LED – Light Emitting Diode
- MUX - Multiplexer
- DEMUX - Demultiplexer
- OXC – Optical Cross Connect
- NSFNET – National Science Network
- COST-239 – European network topology
- USANET – USA standard network topology
- DWDM - Dense Wavelength Division Multiplexing
- ICT – Information and Communication
- DC – Data Center

CHAPTER 1

INTRODUCTION

1.1 Overview

Optical networks are those in which the dominant physical layer technology for transport is optical fiber. They can be opaque or all-optical, and can be single-wavelength or based on dense wavelength division multiplexing (DWDM) [21]. It is a means of communication in which the electrical signal is converted into light to transfer information amongst various nodes of the network with the help of the optical fiber. In Information and Communication (ICT) sector, optical fiber is growing in popularity because of the increasing demand of the bandwidth. Optical networks are considered to be dominant in ICT because of their all-optical approach for a wide-area network, where the information can be transmitted in the optical domain between nodes at a distance of thousands of kilometers. The all-optical approach is applicable for both metro-area network (distance ranging from 1 to 10 kilometer) and local-area network (0 to 1 km) as well. The optical fibers can carry optical signals at different wavelength (or channels)

1.2 Motivation

Since the first electronic computational machine was built in 1946, the energy needed for a computation has been halved about every 19 months through technological advancement [1, 2]. Yet, the problem of energy consumption in ICT sector is an issue because of the exponential growth in the ICT. According to statistics released in the

European Conference of Optical Communication (ECOC) 2012, traffic growth is increasing by 40% per year and electrical power consumption is increasing at a rate of 9% per year [23]. In addition, statistics also indicate that electrical resources are increasing at a rate of 3% per year, while the internet consumes about 5% of the total world electricity and is expected to rise to 8% by 2020 [23]. Data Centers (DC) are considered to be the new polluters as they consume about 91 billion kWh of electricity, a 50% rise in power consumption is expected by 2020 for DCs. There has been considerable research in the area of energy-aware routing in the WDM optical networks and a number of Integer Linear Programming (ILP) formulations and heuristics have been proposed to solve this problem [16, 17, 18, 19 and 20]. Recently, research in energy-aware anycast routing approach for WDM network has gained a lot of popularity. Several approaches for energy aware RWA with anycast routing approach have been proposed in [16], [18], and [20]. In the energy-aware anycast routing scheme, the energy saving is much higher than energy-aware unicast routing scheme as the lightpaths in this scheme are rerouted along the already existing paths, and the inactive network components are switched off [16]. Anycast routing allows to pick the destination node for the demand from the available pool of the destination nodes. For energy-aware anycast routing scheme, heuristic approaches need to be developed for larger sized networks, since optimal ILP formulations quickly. Therefore in our approach, we consider the tabu search heuristic for the static traffic model exploiting the anycast principle.

1.3 Problem Statement and Solution Outline

Growing internet has resulted into increase in the amount of energy consumption. There is a need to address the concern of better energy utilization for increasing number of high

performance and high bandwidth internet applications. Traditional techniques targeting to resolve this problem for WDM network only considers *unicast* routing principle, where the destination node is always pre-determined. In our thesis we are trying to target the problem of high energy consumption in optical grid networks by using *anycast* routing principle in which the destination node for demand and routing scheme is selected by the algorithm based on the cost efficiency. Also, we are trying to reduce the cost of overall network by rerouting the demands through the network components already in use.

Several researches have tried a different approaches addressing this problem [16] - [20]. In this thesis, we have proposed a Tabu search heuristic approach targeting the problem of energy consumption which is suitable for practical sized networks, unlike an ILP formulation which is only suitable for small sized networks.

We evaluated the performance of our heuristic algorithm by comparing the simulation results of our approach with *unicast* and shortest-path approach over different network topologies. The results indicates that our approach can lead to a significant saving in energy consumption compared to the traditional approaches.

1.4 Thesis Organization

The remainder of thesis is organized as follows. Chapter 2 reviews the energy aware routing techniques in an optical network and provides a brief description about the fundamentals of optical network. Chapter 3 presents our proposed tabu search heuristic for energy aware routing in an optical network. Chapter 4 shows the experimentation and

analysis and Chapter 5 provides the summary concluding the thesis along with the directions of future work.

CHAPTER 2

BACKGROUND

2.1 Introduction to Optical Networks

Optical networks are high-capacity telecommunication networks based on optical technologies and components that provide routing, grooming, and restoration at the wavelength level, as well as wavelength-based services [4]. Communication in these networks is achieved with the help of the signals, which are converted into light to transmit information between various nodes of the network. Optical network operate at a limited range network like local-area network (LAN) or over wide-area network (WAN), which can cross metropolitan and regional areas all the way to national, international and transoceanic distances [5]. In this section we will review some of the fundamental concepts of optical networks.

2.1.1 Optical Fiber

Optical fiber is a communication medium in which information is sent in the form of optical signals through the thin strands of pure glass or plastic fiber. The fiber consists of two layers: a core of glass on the inside, and silica cladding on the outside. The light travels through the fiber core, which is surrounded by the cladding that helps in avoiding any transmission loss using an optical technique called total internal reflection. The fiber itself is coated with the buffer to avoid any moisture or physical damage [6], as shown in in the figure 2.1 [6].

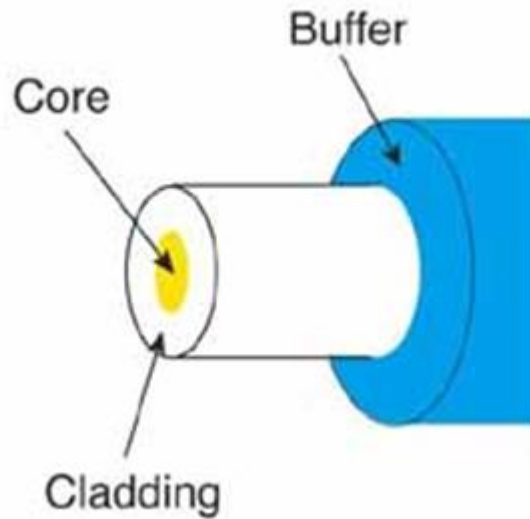

Figure 2.1 Cross-section of Optical Fiber

Optical fibers are of generally two types: multimode and singlemode. The fibers are distinguished based on the size of their core composition. The basic multimode fibers have core size of about 50 to 62.5 microns and transmit multiple rays of light using LED sources. Alternatively, the singlemode fibers have a core size of about 9 microns and transmit a single ray of light using laser sources. Singlemode fibers are usually used for the faster network because of their lower loss and very high bandwidth [6].

The index of refraction of glass or any optical material is a measure of the speed of the light in the material and any change in this index of refraction causes light to bend [6]. Refraction causes light to be reflected from the surface after a certain angle, this reflection is used by the optical fiber to trap light in the core of the fiber, which has a proper index of

refraction. This process is called total internal reflection [6]. Figure 2.2 [7] shows the light propagation in an optical fiber using total internal reflection.

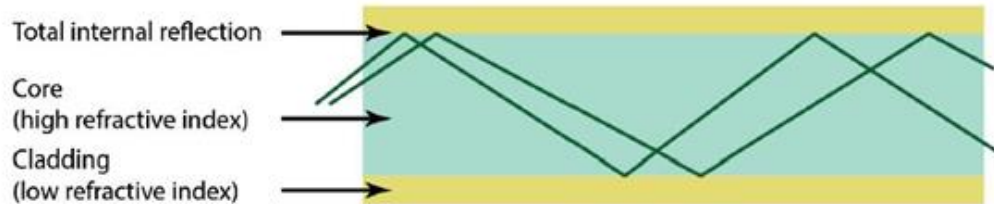

Figure 2.2 Total Internal Reflection

2.1.2 Lightpath

A lightpath is an optical connection or optical communication channel between two nodes of the optical network and carries the information in the form of the encoded signals. A lightpath may traverse through multiple fibers and router nodes between source and destination node in the network [8]. Figure 2.3 below shows an example of 6 lightpaths established over a 5-node physical fiber network.

The lightpaths in the following example are:

Lightpath 1: node 2 → node 1

Lightpath 2: node 2 → node 3

Lightpath 3: node 1 → node 4

Lightpath 4: node 1 → node 5

Lightpath 5: node 3 → node 4

Lightpath 6: node 3 → node 5

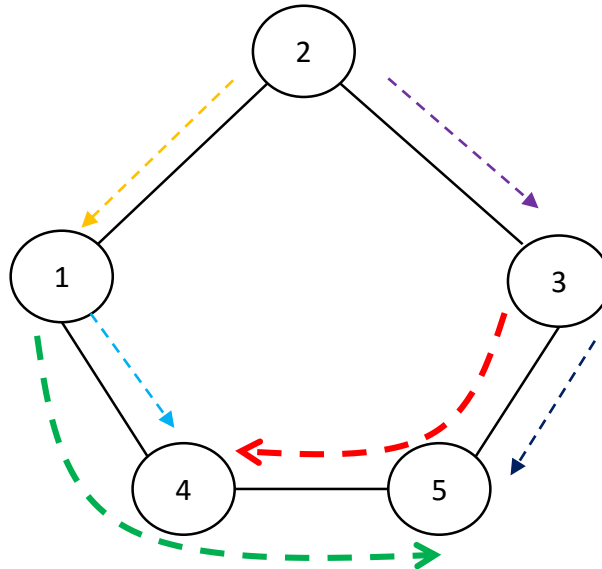

Figure 2.3 Lightpath setup in 5 node network

2.1.3 Physical Topology and Logical Topology

A 5 node optical network is shown in Figure 2.4, which represents the map like structure of the networks components being used in the network. This map like structure shows the relationship among different network components in which the circles represent the nodes of the network and solid lines with arrows represent the actual unidirectional fiber that acts the link between the two end nodes. The physical topology of the network is represented by graph $G [N, E]$, where N is the set of the nodes in the network and E is the edges of the network. Each edge of the network (i.e. the bidirectional link between the nodes) is constructed using two unidirectional links.

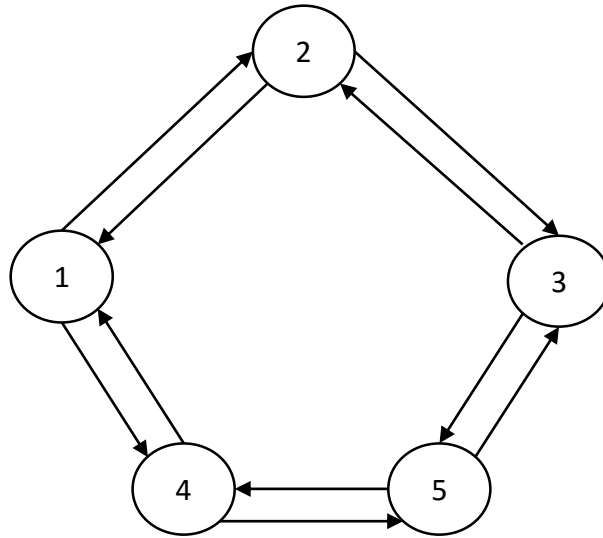

Figure 2.4 Physical Topology

Logical topology reflects the strategy for communication in a network. In this instance, the lightpaths are viewed as the edges in the network connecting to the nodes in the physical topology. These nodes are same as the ones in the physical topology, but the lightpath between the sources and the destination nodes are the logical edges, and this representation of a network is known as a logical or virtual topology [24]. Figure 2.5 represents the logical topology that is established over the physical topology in Figure 2.4, and lightpath setup in Figure 2.3.

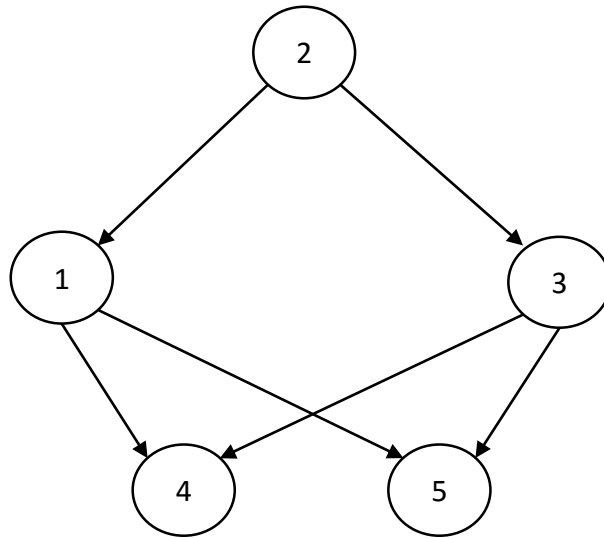

Figure 2.5 Logical Topology

2.1.4 Wavelength Division Multiplexing (WDM)

Increasing demand of internet which is doubling every six months has led a need to develop new technologies to accommodate all the traffic requirement. Wavelength Division Multiplexing is an optical technique in which optical signals of different wavelengths are combined onto a single strand of the optical fiber at the one end and then separated again at the other end of the fiber, this is achieved with the help of the multiplexer at the transmitter's end and demultiplexer at the receiver's end [24]. When this technology was first introduced in 1978, it was only possible to combine 2 signals at a time on a single strand of the fiber, but now as the technology evolves, it is possible to combine 160 signal on the single strand of the fiber at a single time. With this optical technology it is possible to increase the capacity of the network without laying more fibers. Furthermore, this technique has additional advantages like low signal attenuation, low signal distortion, low

power requirement, low material usage, small space requirement and low cost. Figure 2.6 [25] shows an example of the Wavelength Division Multiplexing with all the devices being used which are discussed briefly in this section.

Transmitter (TX): Transmitters in optical networks are the electrical devices used to convert the electrical signals into the optical signals for a specific wavelength. Light-emitting diodes (LED) and laser diodes are most commonly used as transmitter.

Receiver (RX): Receivers in the optical network are the photo-detectors, which are used to convert the optical signals into the electrical signals, using photoelectric effect.

Multiplexer (MUX) and Demultiplexer (DEMUX): Multiplexers in optical network are the devices used to combine the signals of different wavelength onto a single strand of the fiber, whereas Demultiplexers are used to separate the combined signals at the receivers end.

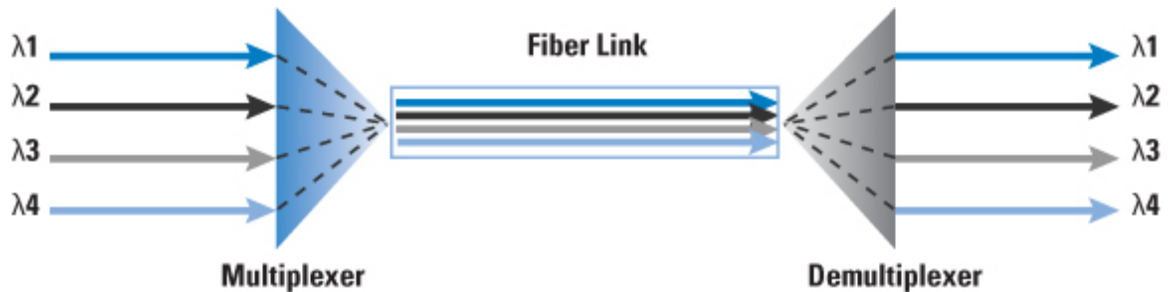

Figure 2.6 Wavelength Division Multiplexing

2.1.5 Routing and Wavelength Assignment (RWA)

Routing and wavelength assignment (RWA) is the fundamental control problem in optical WDM networks [28]. Since the performance of a network depends not only on its physical resources (e.g., OXCs, converters, fibers links, number of wavelengths per fiber, etc.) but also on how it is controlled, the objective of an RWA algorithm is to achieve the best possible performance within the limits of physical constraints [9]. One important objective of RWA is to allocate maximum number of demands in the network and each demand should be assigned and route and a wavelength which remains consistent for the entire path.

There are two constraints which should be satisfied for a valid RWA:

- i. Wavelength clash constraint: This constraint ensures that two lightpaths traversing along the same physical link cannot have the same wavelength.
- ii. Wavelength continuity constraint: This constraint ensures that each lightpath should have the same assigned wavelength for its entire path.

Figure 2.7 shows an example of RWA, over a small 5 node network. The first lightpath routes from $1 \rightarrow 4 \rightarrow 3$, and the second routes from $4 \rightarrow 3$, since both the lightpath traverse from the same physical link $4 \rightarrow 3$, so they cannot be assigned the same channel and hence first one has been assigned channel with wavelength λ_1 and other one has been assigned with channel of wavelength λ_2 . The lightpaths uses the same assigned channel for their entire route and hence both the constraints are satisfied here and it's a valid RWA.

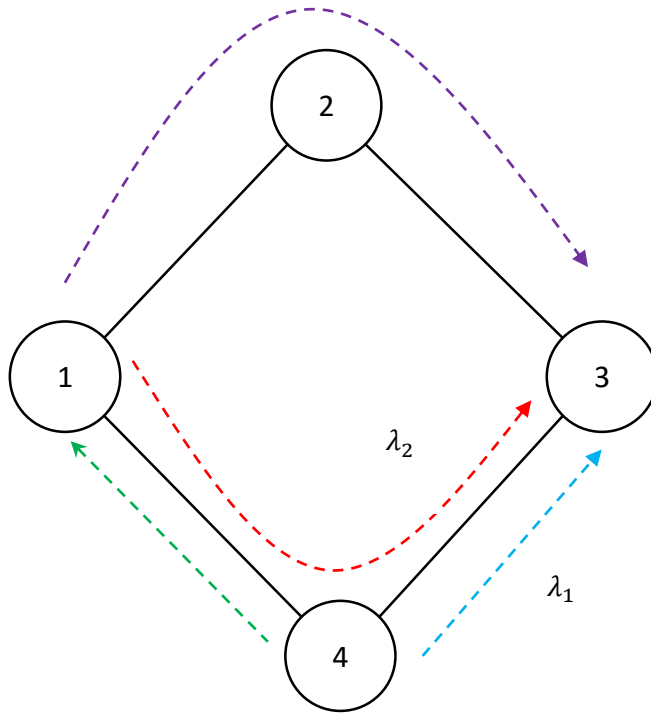

Figure 2.7 Routing and Wavelength Assignment

2.2 Energy Consuming Devices

This section describes about the various devices in an optical network on which the energy is spent for a successful transmission of information amongst various nodes.

Optical Amplifier:

An optical amplifier is a device that amplifies an optical signal directly, without the need to first convert it to an electrical signal. An optical amplifier may be thought of as a laser without an optical cavity, or one in which feedback from the cavity is suppressed [10]. Optical inline amplifier can amplify the signals in the optical domain, without a need to convert them into the electrical signals.

Transceivers:

A transceiver is a device comprising both a transmitter and a receiver which are combined and share common circuitry or a single housing. When no circuitry is common between transmit and receive functions, the device is a transmitter-receiver [11]. This device is used to terminate the optical signals at each end and convert the opto-electric signals for further processing. Figure 2.8 [12] shows and design structure of the transceiver.

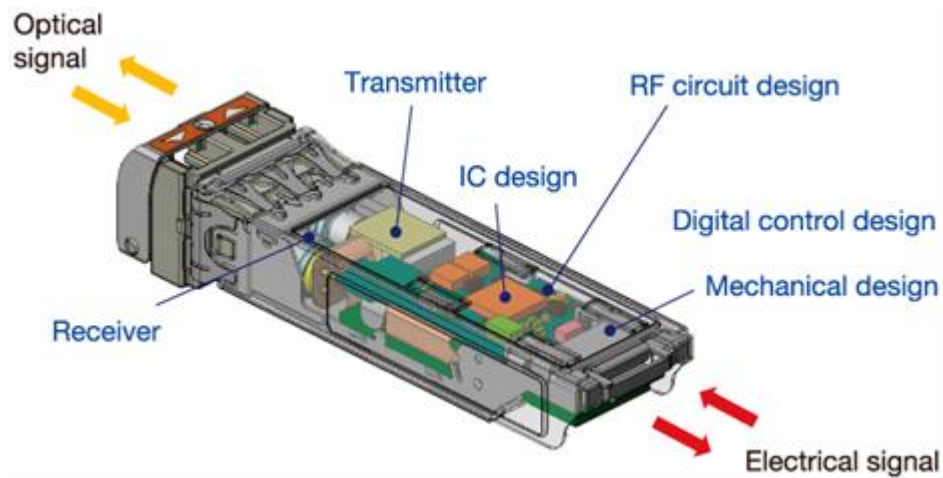

Figure 2.8 Transceiver

IP Router:

A router is a networking device that forwards data packets between computer networks [13]. Routers perform the traffic directing functions on the Internet. A data packet is typically forwarded from one router to another through the networks that constitute the internetwork until it reaches its destination node [13].

Optical cross-connect switch (OCX):

An optical cross-connect (OXC) is a device used to switch high-speed optical signals in a fiber optic network, such as an optical mesh network [14]. OXCs can be used for electrical or optical switching or both. The figure 2.9 [22] shows a typical structure of an optical cross-connect switch.

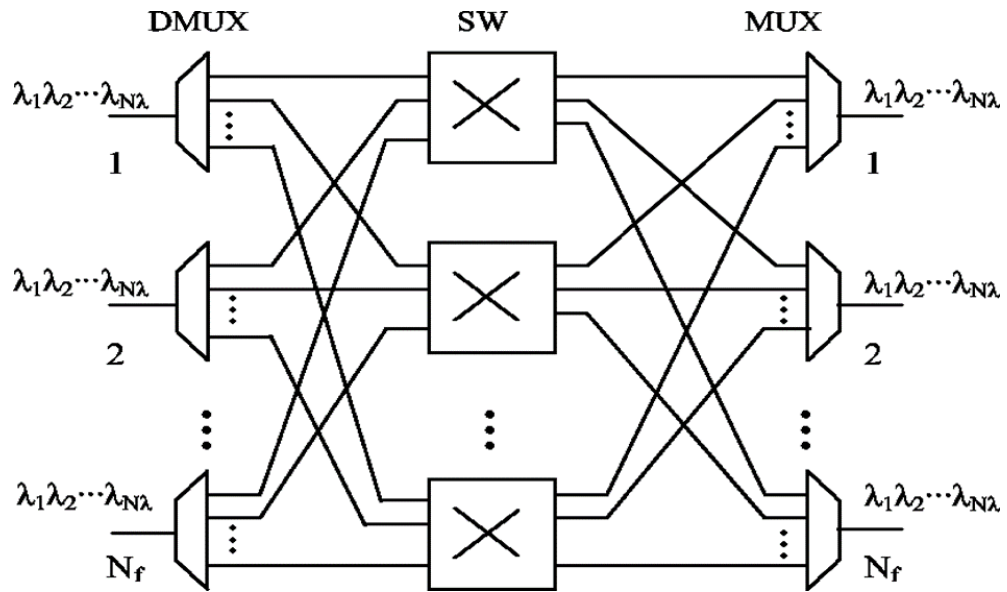

Figure 2.9 Optical cross-connect switch (OXC)

2.3 Optical Grid

Distributed computing as well as the concept of the computational grid is becoming more significant due to the high bandwidth and increasing speed of the internet. Concept of grid computing is used in the large scale and data intensive applications, where two or more network components are connected to each other to share the common resources [5].

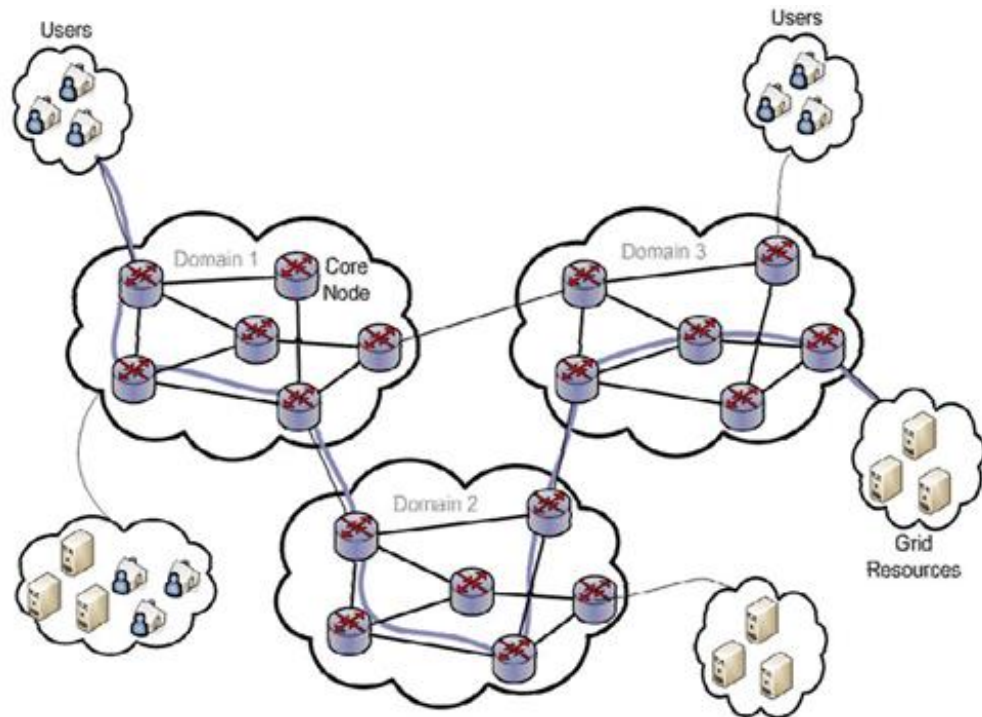

Figure 2.10 Optical Grid

Figure 2.10 [15] shows an example of optical grid network, where two or more end users connected to two or more grid resources in the network, and the connection between them is established with the help of the optical links and the switching equipments.

2.3.1 Unicast Routing

Unicast routing is the process of transmitting traffic from a source node to a destination node and in this process the traffic is forwarded only a unique specified destination. Figure 2.11 show an example of unicast routing in the 6 node network, from

the source node 1 to the unique destination node 3. The traffic may be routed along different paths, e.g. $1 \rightarrow 2 \rightarrow 3$ or $1 \rightarrow 4 \rightarrow 5 \rightarrow 3$, but the destination remains the same.

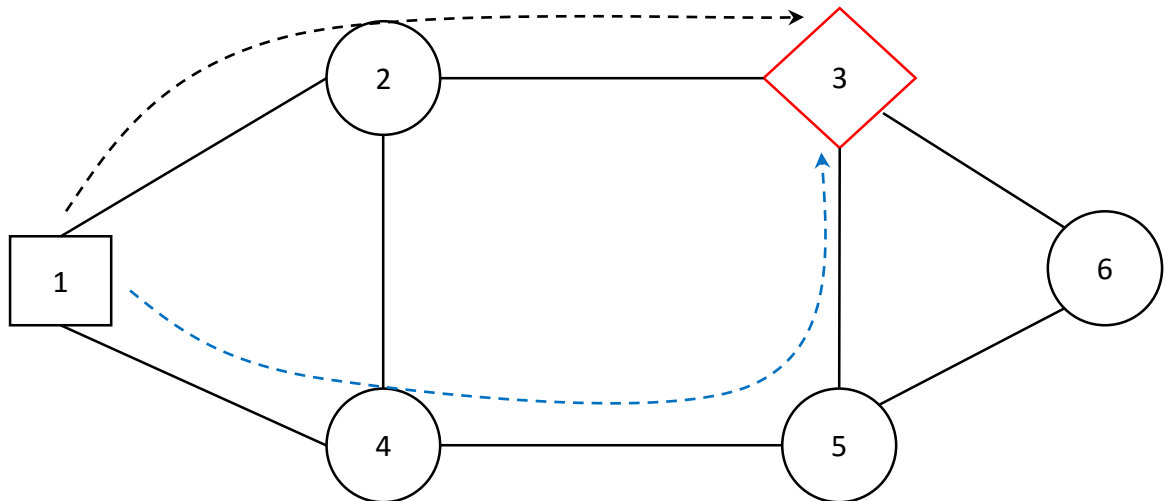

Figure 2.11 Unicast Routing

2.3.2 Anycast Routing

In unicast routing, discussed in previous section, the source and the destination nodes are known in advance and are unique. In optical grid networks, on the other hand, the service location is often not important, as the main goal is to successfully execute the job. This can be very helpful for optimizing the resource allocation process in optical grid network, by using the principle of anycast routing [20]. In anycast routing, the job p generated at the source node can be processed at any destination node d_p from the available pool of the destination nodes D_p where $d_p \in D_p$ the actual destination node d_p is selected on the basis of certain criteria.

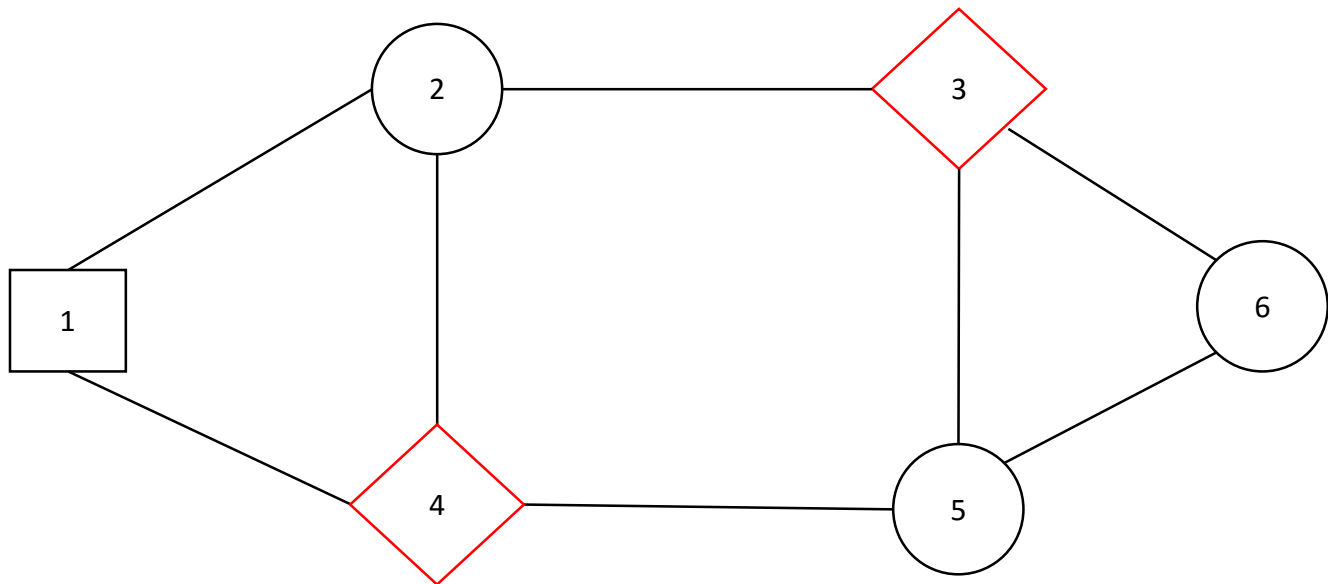

Figure 2.12 Anycast Routing

Figure 2.12 shows an example of anycast routing for 6 node network with a single demand originating at the source node 1 that can be processed at any available destination node, i.e. node 3 or node 4. The destination node is selected in a way that optimizes certain design objectives for the optical network. Our goal in this thesis is to minimize the total energy consumption of the optical network by selecting the best destination node and route to the selected destination, for each demand. This is accomplished by selectively rerouting certain lightpaths in the network and switching off the network components which are not being used.

2.4 Tabu Search

Tabu Search is a Global Optimization algorithm and a Metaheuristic or Meta-strategy for controlling an embedded heuristic technique [16]. The objective of Tabu search algorithm is to prevent the embedded heuristic from returning to the recently visited nodes (i.e. solutions) in the search space. Tabu search is an extension to the hill climbing algorithm [26], which greedily searches the local neighborhood until a local optimum is reached. Whereas, Tabu search looks for a better solution in the global search space. Before discussing the details of Tabu search algorithm, we present some standard terminologies used in the Tabu search algorithm.

2.4.1 Search space and neighbourhood structure

Search space is the simply the space of all the feasible solutions, which can be visited during the search. Sometimes it better to not to restrict the search space with only feasible solution, by allowing the search to move to infeasible solution for better results. Search space is denoted by S . The definition of neighbourhood structure is closely linked to that of search space. Neighbourhood structure $N(S)$ is a subset of search space, i.e. the solutions obtained by applying single local transformation to search space [16].

2.4.2 Tabus

Tabus are the elements in the search which make Tabu search different from hill climbing. Tabus are used to prevent cycling in the search, by not allowing visits to the same step in the solution space. For example, if we have certain node which is visited in the network

and it gives a better solution then it will be stored in the tabu and won't be visited until certain iterations [16].

2.4.3 Aspiration Criteria

Tabus can sometime prove detrimental to the search process, hence it was necessary to device algorithmic process to cancel the Tabus. This is known as aspiration criteria. The most commonly used tabu aspiration criteria is allowing a tabu move when it results in a better objective solution from the current best known solution [16].

2.4.4 Termination Criteria

It is possible that the search process could go on indefinitely, so it is necessary to stop the search at a certain point and this is achieved with the help of the termination criteria. The commonly used termination criterion is terminating the search after certain number of iterations. The other criteria used are terminating the search after certain number of consecutive iterations without any improvement in the best known solution or when the objective value attains the best specified solution [16].

2.4.5 A simple tabu search algorithm

An outline of the typical tabu search algorithm is given below [16]. The first step of this algorithm is to choose an initial solution and make it as the best known solution. The main aim here is to minimize a function $f(S)$. The next step includes searching of the solution in the neighborhood until the better solution is obtained compared to the best known solution or until the termination criterion is satisfied. If a better solution is obtained that that move is made tabu by recording it in tabu list T for a specified duration [16].

The following outline of a tabu search algorithm is taken from [16].

Algorithm 1 Tabu Search Algorithm

Notation

- S , the current solution
- S^* , the best known solution
- f^* , value of S^* ,
- $N(S)$, the neighbourhood of S ,
- $\tilde{N}(S)$, the “admissible” subset of $N(S)$ (i.e., non-tabu or allowed by aspiration),
- T , tabu list

Initialization

Choose (construct) an initial solution S_0

Set $S := S_0, f^* := f(S_0), S^* := S, T := \emptyset$.

Search

While *termination criteria not satisfied* do

- Select S in $\operatorname{argmin} [f(S')]; s' \in \tilde{N}(S)$
- if $f(S) < f^*$, then set $f^* := f(S), S^* := S$;
- record tabu for the current move in T (delete oldest entry if necessary);

Endwhile.

In this algorithm, argmin returns the subset of solutions in $\tilde{N}(S)$ that minimizes f .

2.5 Literature Review

The internet traffic is growing at a rate of 40% per year due to increase in the number of high bandwidth internet application. Internet consumes about 5% of the total world electricity and it is expected to rise to 8% by the year 2020. It is believed that energy consumption cost is superior over the component cost and this is considered as bottleneck for the growth of efficient optical network. This exponential traffic growth in ICT has resulted in development of more energy efficient optical networks. Significant research has been done energy aware unicast routing in WDM network [17, 19] and energy aware anycast routing in WDM network [16, 18, and 20]. Both the approach have a similar aim of reducing the energy consumption, both the static and dynamic power components of the optical network by switching off the network components or rerouting the existing lightpaths over the already turned on optical links using the ILP or heuristic approach. In this section we review most relevant literature to this thesis.

Coiro *et al* [17] appears to be the first to propose energy aware unicast routing in WDM networks. The proposed approach uses an ILP and heuristic to reduce the power consumption of the optical links in the network. In this approach the optical links were turned off by certain heuristic criteria as soon as there was a significant decrease in the traffic load. Optical routers and optical cross connect switches in the network were not considered in this approach. The lightpaths in the network were rerouted on the active links instead of turning on the new links for some demands. This resulted in 28% to 86% lower energy consumption in optical links, depending on the traffic load. On an average, 35% energy saving was observed in the entire optical network through this approach.

Buyse *et al* [16] proposed an approach exploiting anycast routing in optical network for reduction in energy consumption. Reduction in energy consumption was considered for the optical networks both with and without wavelength conversion. The proposed approach aimed at selecting the best destination node by exploiting anycast principle to switch of the unused network components. This resulted in about 25% reduction in energy consumption compared to unicast routing for a standard network, with IP routers, OCX switches and fiber links used to connect them. The authors conducted experiments using COST-239 European networks with 11 nodes and 26 uni-directional links with each fiber supporting 16 wavelengths. Authors claimed that the fiber links account for the 30% of the total energy consumption, whereas OCX and other network components accounts for the rest 70% of the total energy consumption. On an average this approach resulted in 20% of energy saving for the entire network considered for the experimentation.

Tafari *et al* [18] presented a distributed lightpath allocation algorithm based on anycast routing. Authors believe that distributed application such as computational grids are considered to be the major factors that result in increasing traffic. The authors propose a distributed framework with an aim to reduce energy consumption in the WDM backbone transporting the traffic between the node and computational grid by exploiting anycast routing [18]. In this system each nodes switches between active and sleep mode with an aim to maximize the energy savings in the network. Each node maintains 2 thresholds, which determine its active and sleep state and directly affect the network performance.

Authors have considered various topologies for the purpose of simulations, networks ranging from a 6-node network to 14-node NSFNET network [27]. Each optical

link accommodates 16 wavelengths, and each full wavelength channel can accommodate one request operating at rate 10Gpbs [18]. They compared the results for networks with energy unaware routing, Active Sleep Mode (ASM) and Sleep Mode (SM). Numerical results showed that energy unaware scheme performed the worst; ASM performed the best amongst all the three with a significant amount of energy saving of up to 35% with 40 lightpath demands.

In [19], Kantarci *et al* present a novel approach towards the energy aware routing in optical fiber. The authors in this approach propose a three stage MILP which aims at reducing the transport energy of the network and maximize the power saving by the data centers (DC), which are located at the core of the IP-over-WDM network. The authors have also proposed three heuristics in this approach; two behave similar to the MILP aiming towards the power saving and minimizing the propagation delay in the network. The third heuristic aims to compromise between the power saving and propagation delay. For experimentation authors have considered 2 topologies viz. cloud over a 6 node network and cloud over NFSNET network with 14 nodes for all the MILP proposed in this approach. All the experiments performed in this approach are considered for the above mentioned network with static bandwidth. The experimental results shows that MILP-1 and MILP-2 performed better in overall energy saving for transport network and DCs over MILP-3. As the size the size of the network increased the MILPs became time inefficient and the proposed heuristics performed better.

Chen *et al* [20] state that the optical grids are considered to be the best and emerging platform for satisfying the growing bandwidth demands because it is possible to select the best destination from the pool of the available destination for a specific job. In this paper,

the authors proposed an ILP which selects the best destination and performs RWA which leads to the overall energy saving for the network. They also proposed a 2-stage ILP which performed faster for the larger networks. Simulations were carried out using the 11-node COST-239 topology and 14-node NFSNET topology. The total power in this approach is calculated by summing up power consumption of all the network components like OCX, IP router, fiber link and various amplifiers. The authors compared their approach with an energy-aware unicast approach and an energy-unaware anycast approach and their proposed approach performed better in comparison to both of the approaches. The energy saving for the overall network with this approach ranged from 35% for 40 demands to about 15% for 120 demands.

2.5.1 Summary of Literature Review

Table 2.1 shows a summary of the most relevant papers related to this thesis.

Reference	Traffic Model	Traffic Granularity	Routing Scheme	Solution Approach
Buysee et al. 2011	Static traffic model	Sub-wavelength	Anycasting	ILP
Coiro et al. 2011	Static traffic model	Sub-wavelength	Unicasting	ILP/ Heuristic
Tafani et al. 2012	Dynamic traffic model	Lightpath	Anycasting	ILP
Kantarci et al. 2012	Static traffic model	Lightpath	Unicasting	ILP/ Heuristic
Chen et al. 2013	Static traffic model	Lightpath	Anycasting	ILP

Table 2.5.1 Literature Review Summary

CHAPTER 3

ENERGY AWARE ROUTING IN OPTICAL NETWORKS

3.1 Introduction

In this chapter we will discuss about our proposed approach towards energy efficient optical networks using Tabu search heuristic algorithm, along with unicast and anycast principle to achieve the objective of reducing the total power consumption of the network by using efficient routing scheme. Statistics reveal that, internet traffic growth is increasing by 40%, and the electrical power is increasing at the rate of 9% per year. Also, the electrical resources are increasing at the rate of 3% per year, whereas the internet consumes about 5% of the total world electricity and this is expected to rise to 8% by 2020 [22]. This higher rate of energy consumption is resulting into point of congestion for the optical networks.

3.2 Network Energy Model

Fig 3.1[20] shows a transparent IP-over-WDM network architecture used in this work; each node in the network consists of an optical cross connect (OXC) switch which is connected to an IP router. Power consumption of the network nodes and as well as for

amplifiers along the fiber link are taken into consideration. Below equations can be used to calculate the total power consumption of: IP router, optical cross connect (OXC) switch and amplifiers in the network.

$$P_{IP} = P_{IP_low} + P_{IP_ON} + P_{IP_dyn} * t_{IP} \quad (3.1)$$

$$P_{SW} = P_{SW_low} + P_{SW_ON} + P_{\lambda} * t_{\lambda} \quad (3.2)$$

$$P_{link}^e = P_{pre} + P_{post} + P_{inline} \quad (3.3)$$

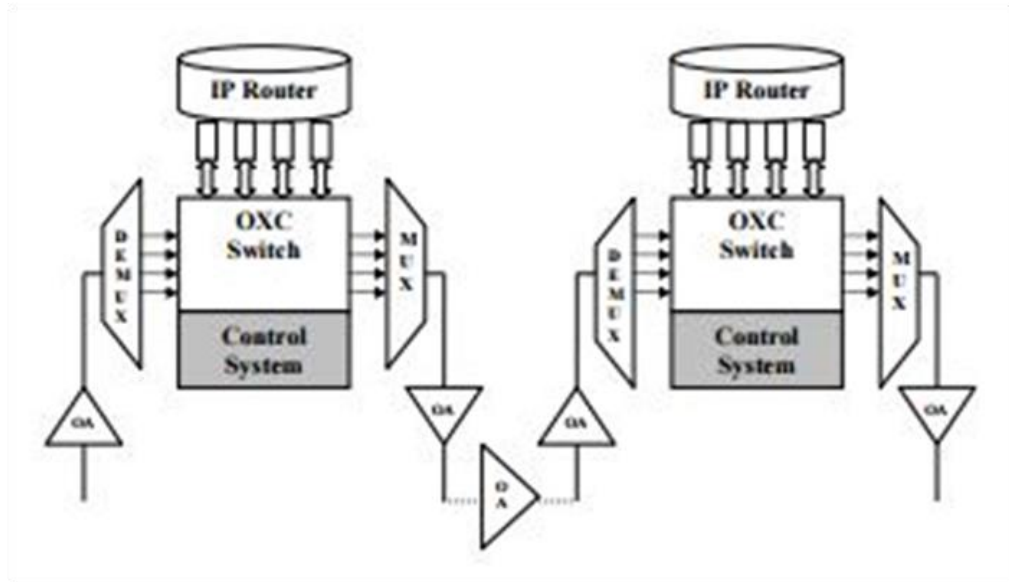

Figure 3.1 Network Energy Model: Transparent IP-over-WDM network architecture

In equations 3.1 and 3.2, the first terms, P_{IP_low} and P_{SW_low} respectively, indicates the power consumption of the corresponding devices in low power or *inactive* state, i.e., when there is no traffic flow. The second terms P_{IP_ON} and P_{SW_ON} denotes the static power consumption of the devices when they are turned *ON* or are in *active* state. Finally, third

term indicates the *dynamic* or traffic dependent power consumption of the device, which is proportional to the amount of traffic (t_{IP} or t_{λ}) flowing through the network component. Additionally, P_{link}^e in equation 3.3 is the total power consumption of an active fiber link e . The total power consumption by an active fiber link is obtained by determining the number of inline amplifiers, which depends on the length of the fiber link, and pre and post amplifiers associated with each active fiber link. Table 3.1 [20] shows the power consumption of different network components mentioned above.

Device	Symbol	Power Consumption
IP Router (Static)	P_{IP_ON}	150 W
IP Router (Dynamic)	P_{IP_dym}	17.6 W per λ
Electronic Control System	P_{SW_ON}	100 W
Optical Switch	P_{λ}	1.5 W per λ
Pre-amplifier	P_{pre}	10 W
Post-amplifier	P_{post}	20 W
In-line amplifier	P_{ILA}	15 W
Transponder	P_{TR}	34.5 W

Table 3.1 Power consumption of network devices

3.3 Solution Approach

In our work we are using the anycast principle along with Tabu search such that we can select the destination from the pool of available destinations. Also, we are trying to use

the network elements already in use to handle the existing or new traffic demands to reduce the power consumption resulting from the use of new network elements. Before discussing the proposed Tabu search heuristic approach, we will illustrate our approach with a simple example.

We consider a 6-node network in Fig. 3.2, which consists of 6 nodes and 8 edges with 3 lightpaths labelled as l_1 , l_2 and l_3 . Additionally there is one more lightpath l_4 , which will be considered for rerouting over the network components already being used.

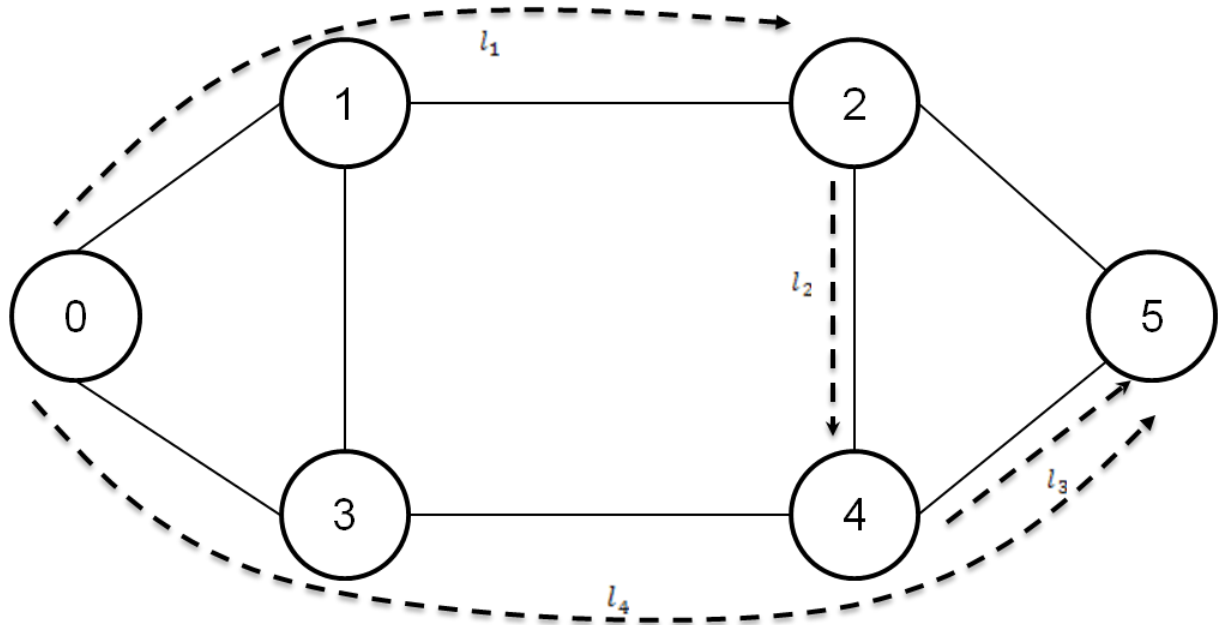

Figure 3.2 6-Nodes Network Physical Topology

In Fig. 3.3, l_4 is routed from source node 0 to destination node 5 along the path $0 \rightarrow 3 \rightarrow 4 \rightarrow 5$. This being the initial path is not efficient in terms of power consumption, because if we look at the path it is using nodes and links which were not used earlier and

it possible to reroute this demand to active links in the network. Table 3.2 shows the power consumption of each node and link in the network being used for the initial solution.

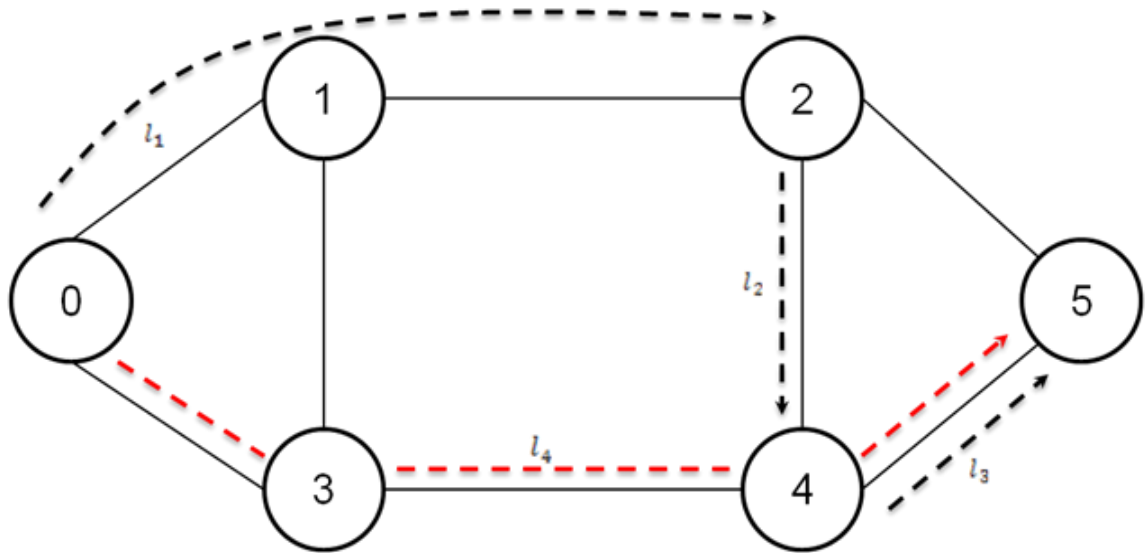

Figure 3.3 6-Nodes Network with in-efficient route

Nodes	Power Consumption (W)	Edges	Power Consumption (W)
0	288.2	e_0	90
1	103	e_2	90
2	288.2	e_4	60
3	103	e_8	60
4	289.7	e_{12}	60
5	288.2	e_{14}	105

Table 3.2 Power consumption for RWA for network in Figure 3.2

Demand l_4 can be rerouted in many possible ways to reduce the energy consumption of the network. In the current path, for demand l_4 , node 3 and links between $0 \rightarrow 3$ and $3 \rightarrow 4$ needs to be activated which results into more cost for routing the demand through this network. The routing scheme should be such that the least number of network components are used to accommodate maximum number of demands in a network. It is possible to reroute the path for demand l_4 by using path $0 \rightarrow 1 \rightarrow 2 \rightarrow 5$ such that only one extra link will be required to be activated in order to satisfy the demand.

Fig 3.4 shows a network with efficient routing scheme, such that only link between node 2 and 5 needs to be activated for routing. The cost of routing along this path will be much lower as compared to the initial path which requires turning on a node and 2 links.

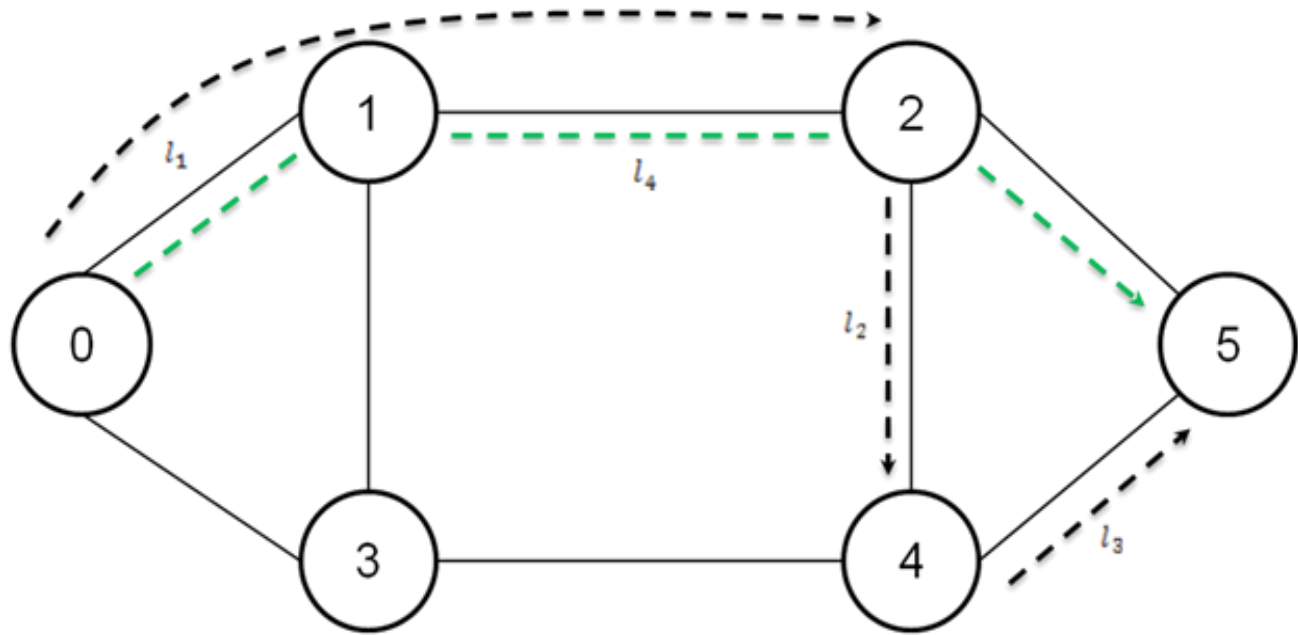

Figure 3.4 6-Nodes network with efficient routing scheme

This will result into the decrease of the static and dynamic power consumption of the node 3 which was required to be activated only for demand l_4 as well as the power consumption by the amplifiers between the node $0 \rightarrow 3$ and $3 \rightarrow 4$. Whereas, in the efficient way of routing only a link between nodes $2 \rightarrow 5$ will be required to be turned on as all the other components are already being used for other demands. It can be seen from the table 3.1 that the static component of power consumption for both the IP router and OXC is dominant compared to the dynamic component of power consumption, so in this case, only the dynamic component of power consumption will be calculated while considering the new routing schemes as all the nodes required along the path are already turned on.

3.4 Proposed Tabu Search Algorithm

In this section we represent our energy aware Tabu search heuristic algorithm shown in Figure 3.5. In the first step of the algorithm, the initial solution is constructed and stored as the current solution and global best solution. Also, cost of initial solution is calculated and stored as the current best cost and global best cost for the solution. The initial solution and cost are calculated by selecting the shortest path for routing each demand.

1. LP_{list} = list of demands to be routed through network
2. For each $l \in LP_{list}$ construct initial solution
3. While *termination criteria* not satisfied do steps 4 – 8
4. Select a demand l for rerouting, based on *selection criteria*
5. $P_{savings}$ = Totals savings if demand l is removed from its current route
6. For each alternate route r of demand l
 - Add r to the neighbor list (N_{list}) if at least one channel is available on each edge e in route r .
7. From N_{list} , select the least cost route r such that
 - a. Cost of r is less than $P_{savings}$ and
 - b. Using route r for demand l is admissible.
8. IF a suitable route is found in Step 7
 - a. Update the current solution and costs for the network as needed.ELSE call DIVERSIFY to generate a new solution
 - a. Update the current solution and costs for the network as needed.

Figure 3.5 Overview of Energy-Aware Tabu Search Heuristic Algorithm

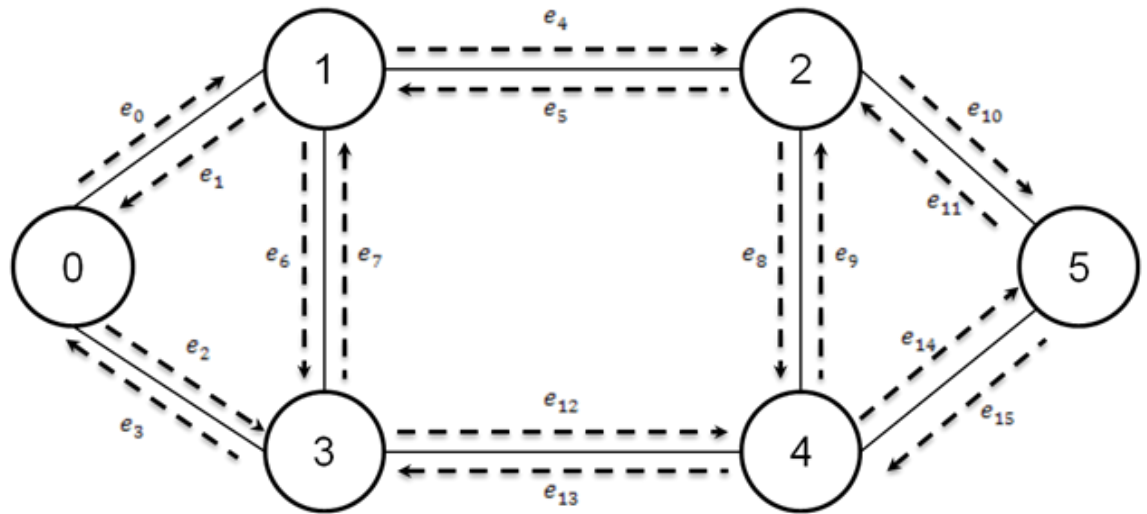

Figure 3.6 Edge information for the 6-nodes network

Figure 3.6 shows a 6-node topology. Each bidirectional link in the topology consists of two unidirectional edges, shown using dashed lines and labelled with the corresponding edge numbers. Five lightpath demands l_1 , l_2 , l_3 , l_4 and l_5 are to be established over this 6-node topology. Table 3.3 shows the information about all the demands and possible routes that may be used by each demand. The routes are specified in terms of the edges to be traversed, and for each demand, p_0 represents the shortest path between the source and destination of the lightpath demand.

Demand	Possible Path p_0	Possible Path p_1	Possible Path p_2
$l_1(0 \rightarrow 1)$	e_0	$e_2 \rightarrow e_7$	-
$l_2(0 \rightarrow 4)$	$e_2 \rightarrow e_{12}$	$e_0 \rightarrow e_4 \rightarrow e_8$	-
$l_3(0 \rightarrow 5)$	$e_2 \rightarrow e_{12} \rightarrow e_{14}$	$e_0 \rightarrow e_4 \rightarrow e_{10}$	-
$l_4(2 \rightarrow 4)$	e_8	$e_{10} \rightarrow e_{15}$	$e_5 \rightarrow e_6 \rightarrow e_{12}$
$l_5(2 \rightarrow 5)$	e_{10}	$e_8 \rightarrow e_{14}$	-

Table 3.3 Potential paths for demands

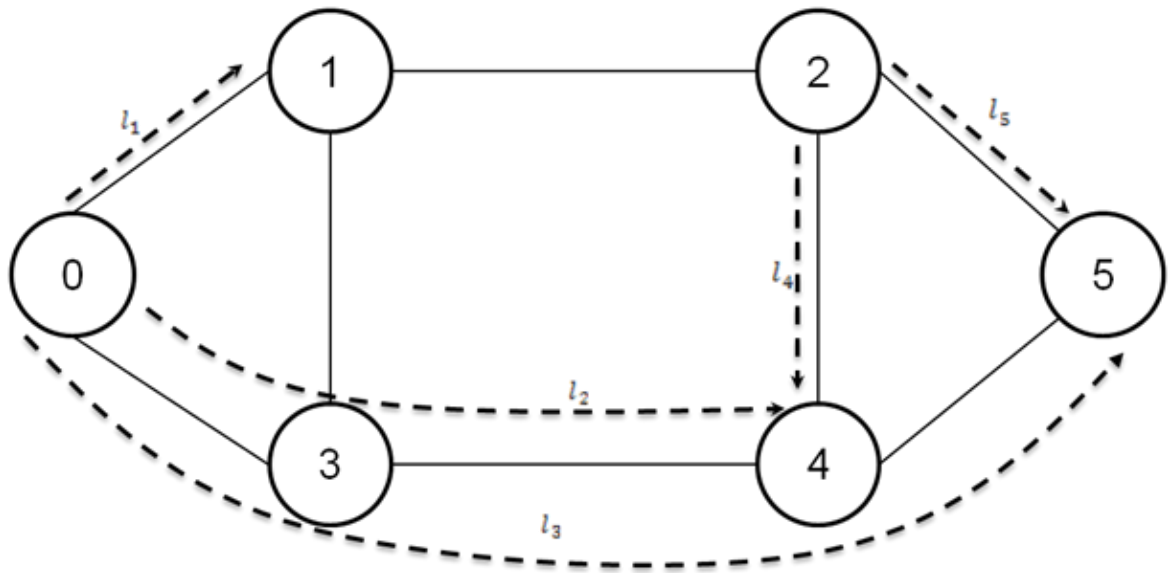

Figure 3.7 6-nodes network with 5 demands

Figure 3.7 shows the five lightpaths routed using the shortest paths over the given topology. This is taken as the initial solution for our problem and can be represented as shown below in Fig. 3.8. Each entry corresponds to one lightpath demand and the value for that entry represents the route used for the demand. In this case, all values are set to 0, because each demand is routed using the shortest path (p_0). At this step Tabu list (T) is empty.

0	0	0	0	0
---	---	---	---	---

Figure 3.8 Initial Solution

The next step of algorithm is to explore the neighbourhood of the current solution and get better results, i.e. much more power savings in the consumption. For this, a single demand is rerouted along a different route from the list of possible route for that demand. It can be seen from table 3.3 that apart from the shortest possible path p_1 , demand can be rerouted on the possible path p_2 and p_3 . In the next step the savings is calculated for removing rerouted demand, so that it becomes easy to compare the cost of the new route and the existing route. Savings for the rerouted demand is achieved by calculating the total power consumption of: IP Routers, OXCs and amplifiers as shown in the equation 3.4.

$$P_{savings} = P_{L_{IP}} + P_{L_{OXC}} + P_{L_{AMP}} \quad (3.4)$$

The next steps points towards finding the neighbors for rerouted demand. The total cost of all the neighbors is calculated for the rerouted demand and the solution is checked for its admissibility. The solution is considered admissible if the neighbor is not in the Tabu list and its cost is less than current cost or if the neighbor is in Tabu list, the neighbor cost should be less than the global best cost. If the solution is admissible, than this solution is

considered as best solution until the next better solution is found. If, after certain number of intervals, a better solution is not found we perform diversification such that a solution is chosen from the available list of feasible solution and entire steps are repeated for that solution as in it is an initial solution. Diversification is performed so as to explore much better results compared to the global best solution and cost. All the above steps are carried out until the termination criteria is satisfied for the Tabu search algorithm. Whenever a feasible solution is found the demand number and the shortest path number are added to the Tabu list. Any entry in the Tabu list becomes “*tabu*” i.e. it can be used until specified number of iterations. Flow of the algorithm can be better understood from the flowchart in the figure 3.11. For the example shown in figure 3.7 along with the information from table 3.3, the best solution after certain criteria achieved can be traced as in figure 3.9 and 3.10.

0	1	1	0	0
---	---	---	---	---

Figure 3.9 Global best solution – showing best possible paths for demands

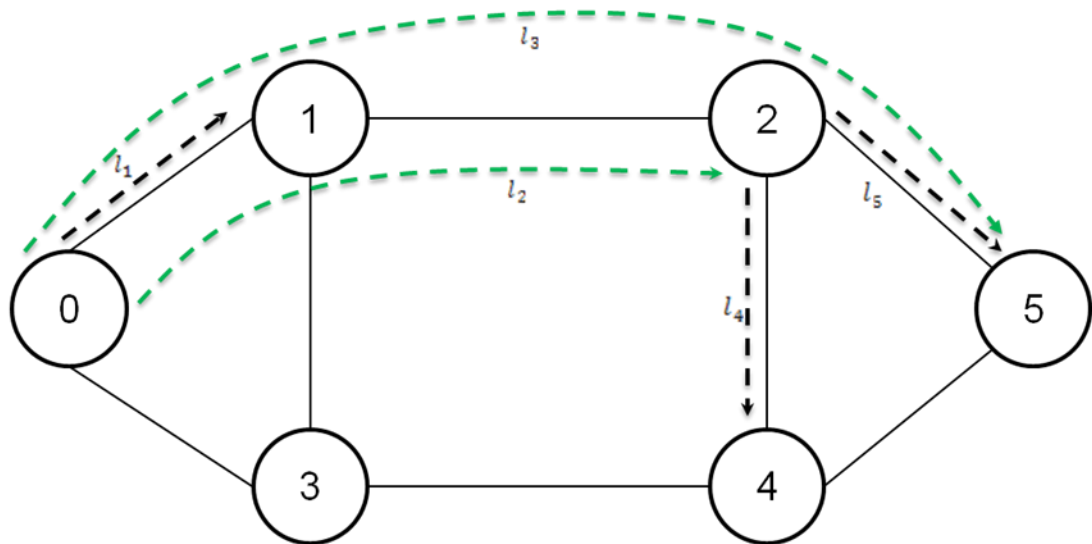

Figure 3.10 Efficient routing scheme for 6-node network

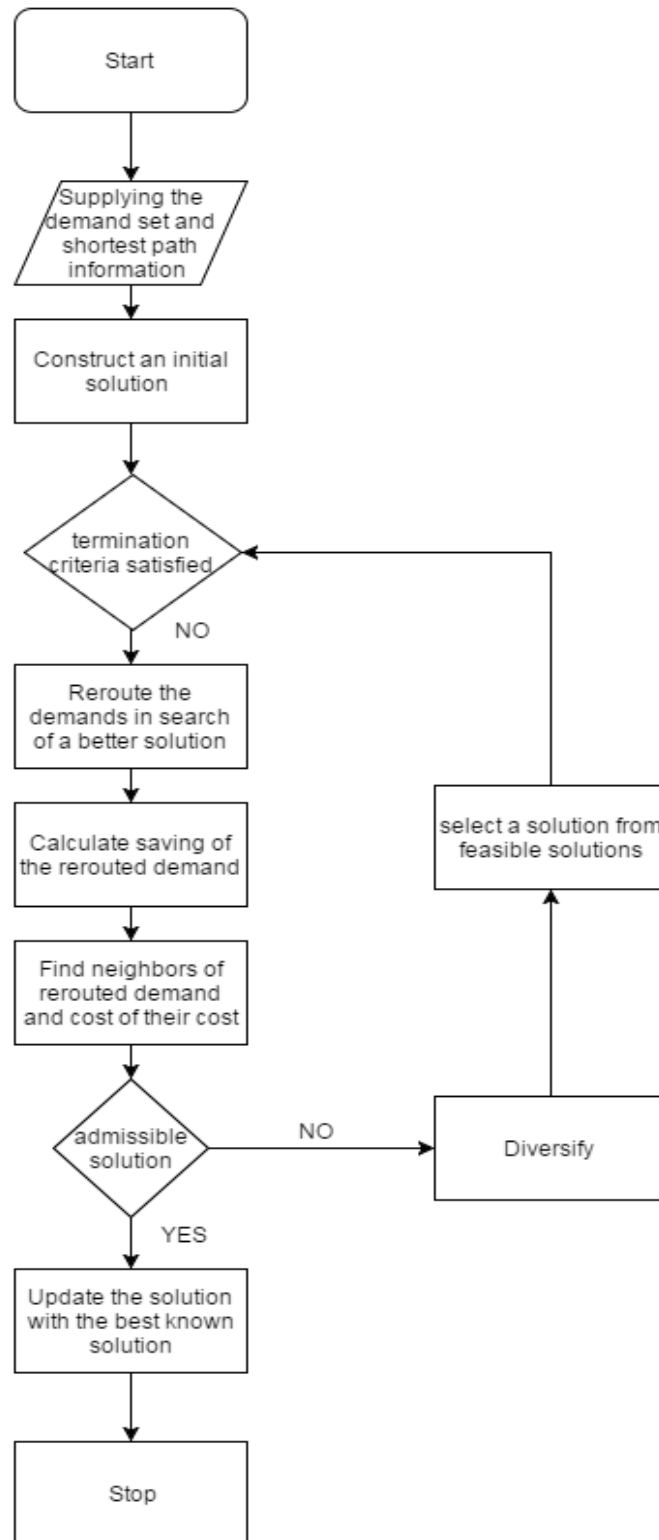

Figure 3.11 Flowchart for energy Aware Tabu Search Heuristic Algorithm

CHAPTER 4

EXPERIMENTATION AND RESULTS

In this chapter we discuss about our network model, experiments performed and results obtained using our Tabu search approach. Results reported in this chapter are the average of 5 different demand sets for each topology and demand set size considered for simulation. Our Tabu search heuristic approach is able to produce results for practical sized networks. Our heuristic algorithm considers a set of pre-computed paths between each source and destination node pair, for a given network.

4.1 Simulation setup

4.1.1 Network topology

In this work we have considered several standard and widely used network topologies to perform experiments for our Tabu search approach. The size of these topologies range from 11 nodes to 24 nodes; the topologies used include, COST-239 shown in figure 4.1 [29], NSFNET shown in figure 4.2 [30] and USANET shown in figure 4.3 [31]. We have performed experiments for different demand set sizes ranging from 10 demands to 200 demands, for each topology. The simulation was run for 5 times for each of the demand set size, for each topology. The results reported are the average of the different simulation runs, for each scenario.

4.1.2 Algorithm inputs

The following parameters are given as inputs to our heuristic algorithm:

Network Topology: The network topology (N, E) consists of defined set of nodes (N) and fiber links (E) connecting the nodes of the network.

Set of possible paths: For unicast routing, each demand has a specified source and destination node. For each demand in the demand set for a network we have pre-computed a set of possible paths between the source and destination node.

Possible destination nodes: For anycast routing, the actual destination node is not specified beforehand. In this case, a set of possible destination nodes (D) is provided as an input. So only the source node of the demand is specified, and the algorithm selects a suitable destination node, from the set D .

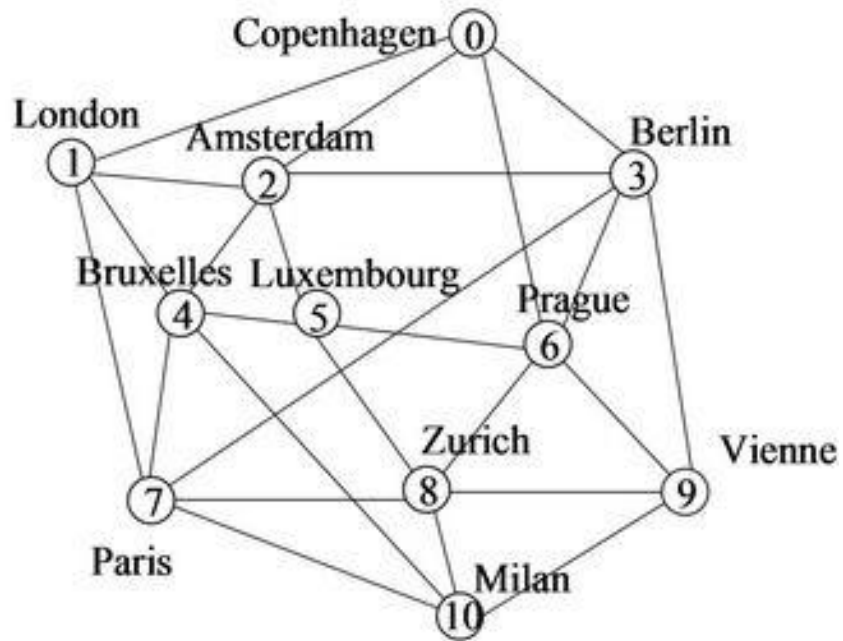

Figure 4.1 COST-239 – 11 node network topology: 52 bidirectional links

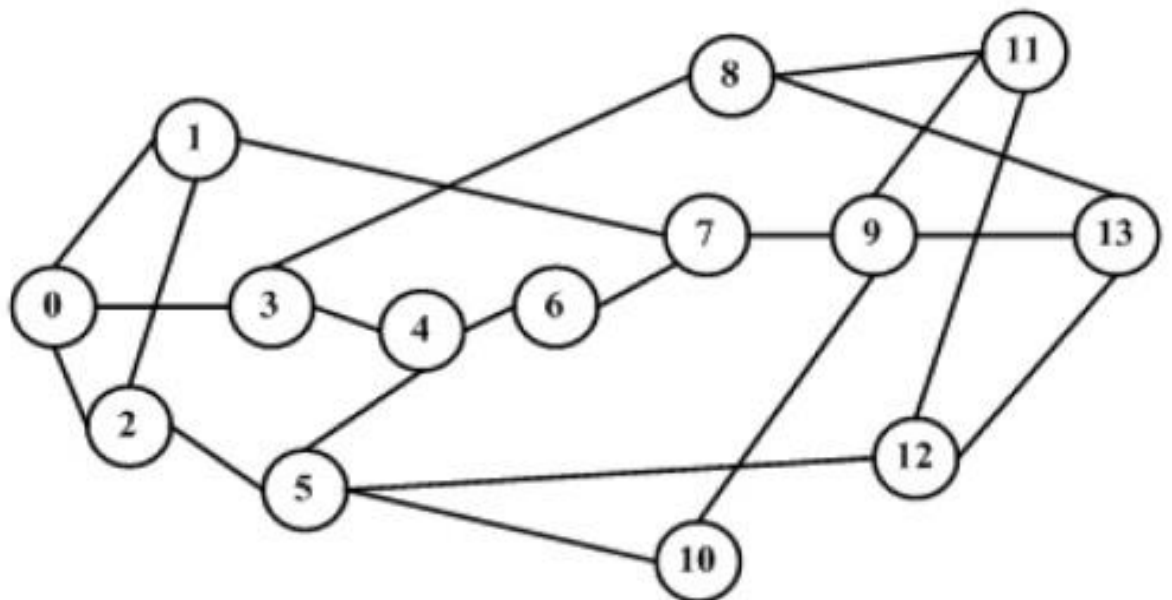

Figure 4.2 NSFNET 14-node network topology: 42 bidirectional links

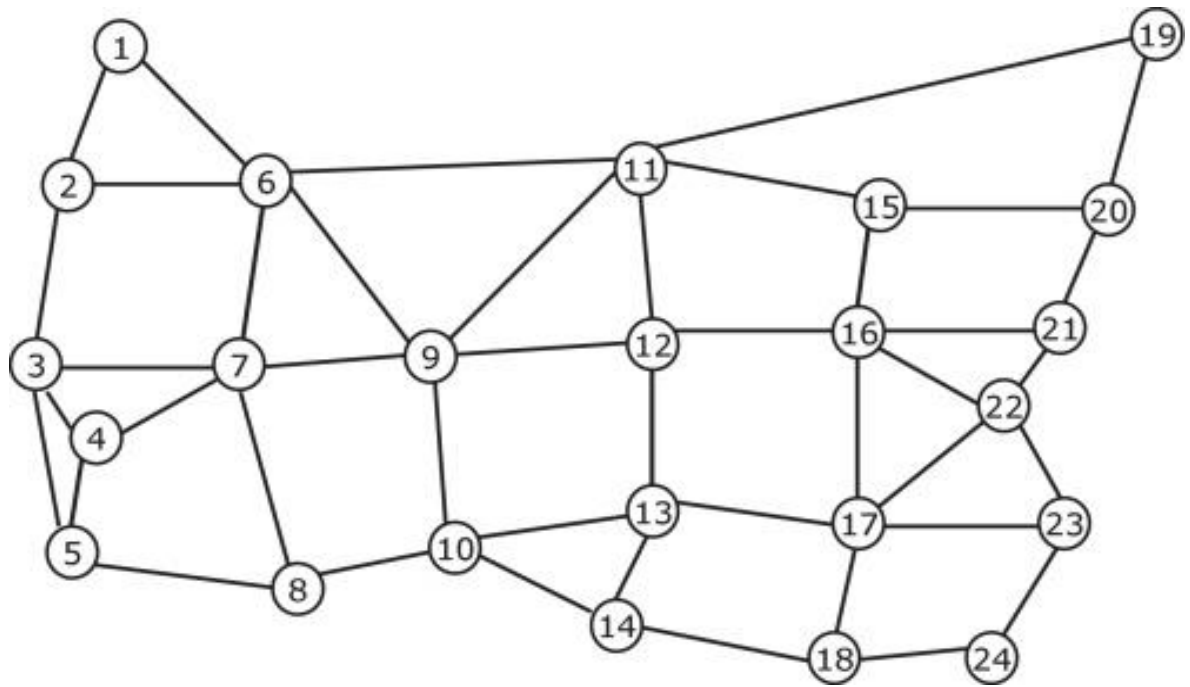

Figure 4.3 USANET 24-node network topology: 86 bidirectional links

4.2 Comparison of Tabu search heuristic

The first approach considered in our work is to select the shortest path for all the demands and perform RWA, this is a commonly used approach, which provides a feasible solution for any topology. We have considered this shortest path approach as the base case for our comparisons, and have compared it with our Tabu search heuristic using both unicast and routing. In our simulations, we considered fibers links with 8 and 16 available channels per fiber. The results shown this section correspond to fibers with 16 channels. The results for 8 channels followed a very similar pattern, and are not shown separately.

4.2.1 Comparison of energy consumption and number of nodes

Simulations were run for various topologies, for different demands sets like: 20, 30, 40, 100 and 200 demands. Figure 4.4 shows the graphical representation of comparison of energy consumption for all 3 considered topologies with 20 demands. The results clearly indicate that the Tabu search heuristic, for both *unicast* and *anycast* routing, performs better compared to the shortest path approach. Figures 4.5 and 4.6 show corresponding results for demand set sizes of 40 demands and 200 demands respectively. On average our proposed Tabu search heuristic approach for *unicast* routing provides 20% reduction in energy consumption, compared to shortest-path approach. Furthermore, the proposed *anycast* routing approach provides an additional improvement of about 9% over the unicast approach.

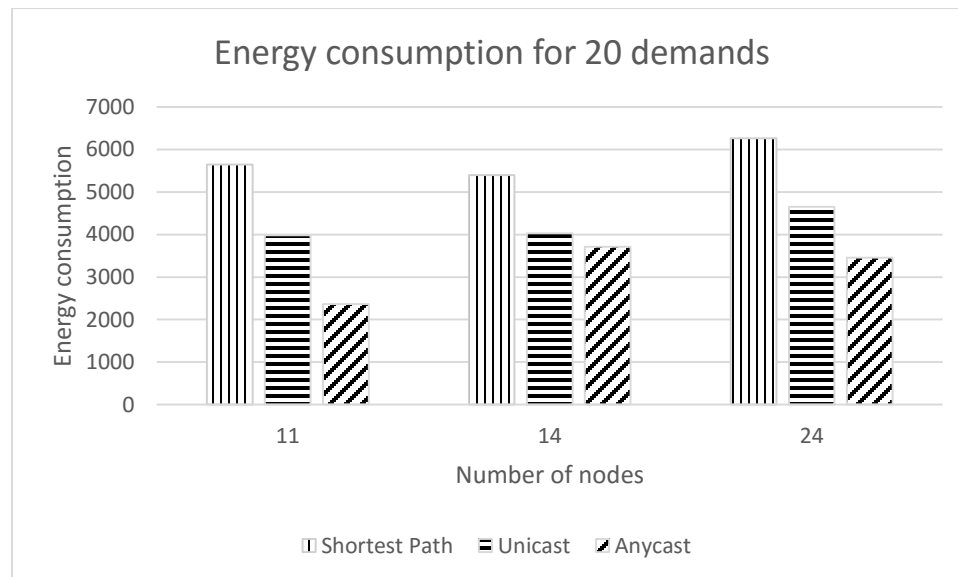

Figure 4.4 Comparison of energy consumption for 20 demands

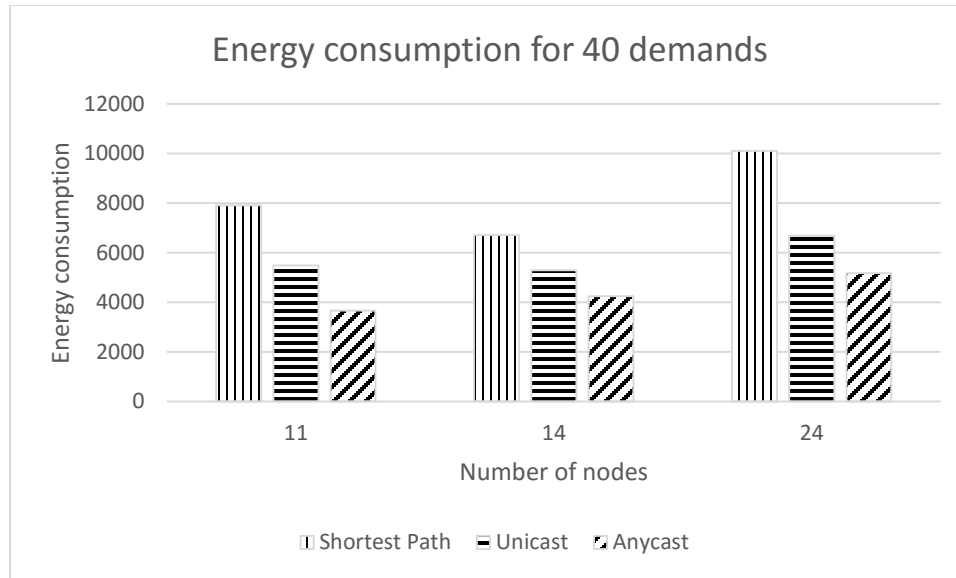

Figure 4.5 Comparison of energy consumption for 40 demands

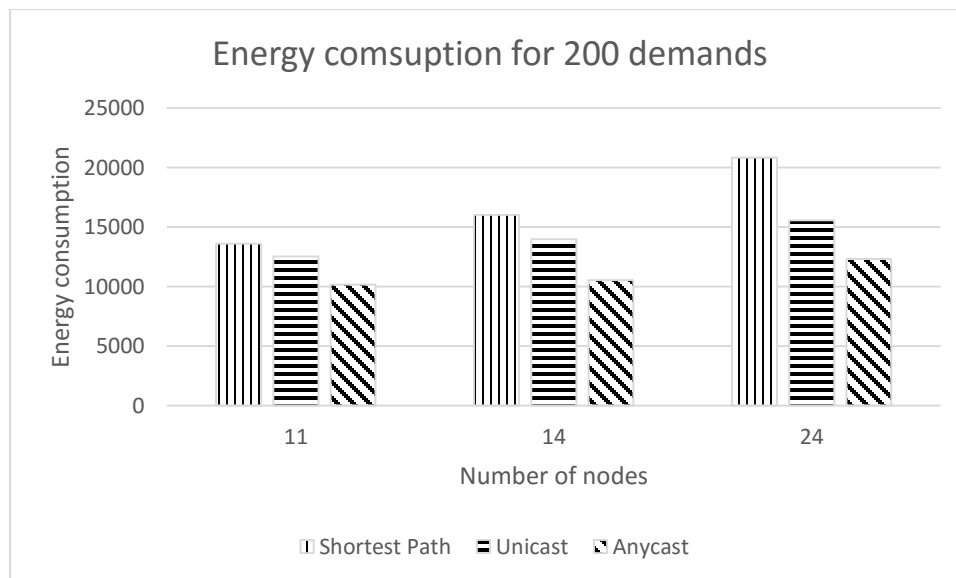

Figure 4.6 Comparison of energy consumption for 200 demands

4.2.2 Comparison of energy consumption and demand size

Figure 4.7 shows how the energy consumption varies with demand size for the 11-nodes topology. As expected, energy consumption increases steadily with demand size, since more equipment need to be in active state to accommodate more demands. The Tabu search algorithm for anycast routing performs the best, and the shortest path approach performs the worst. Figures 4.8 and 4.9 show the corresponding results for the 14-node and 24-node topologies respectively.

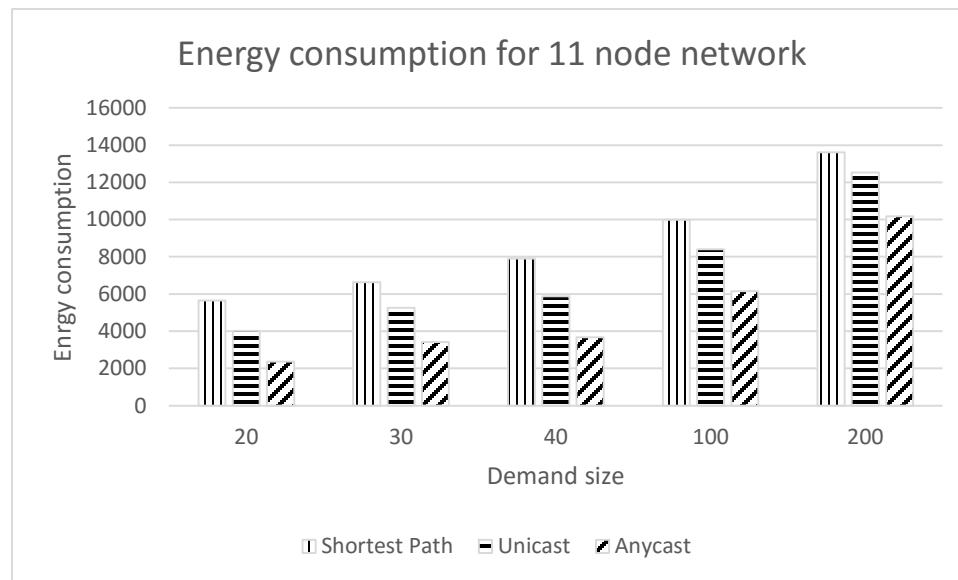

Figure 4.7 Comparison of energy consumption for 11-node network

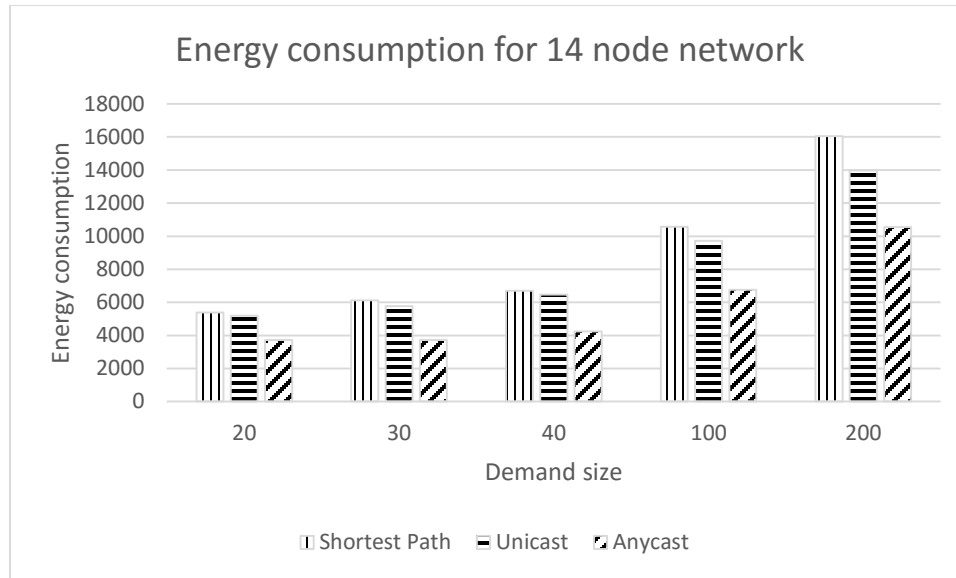

Figure 4.8 Comparison of energy consumption for 14-node network

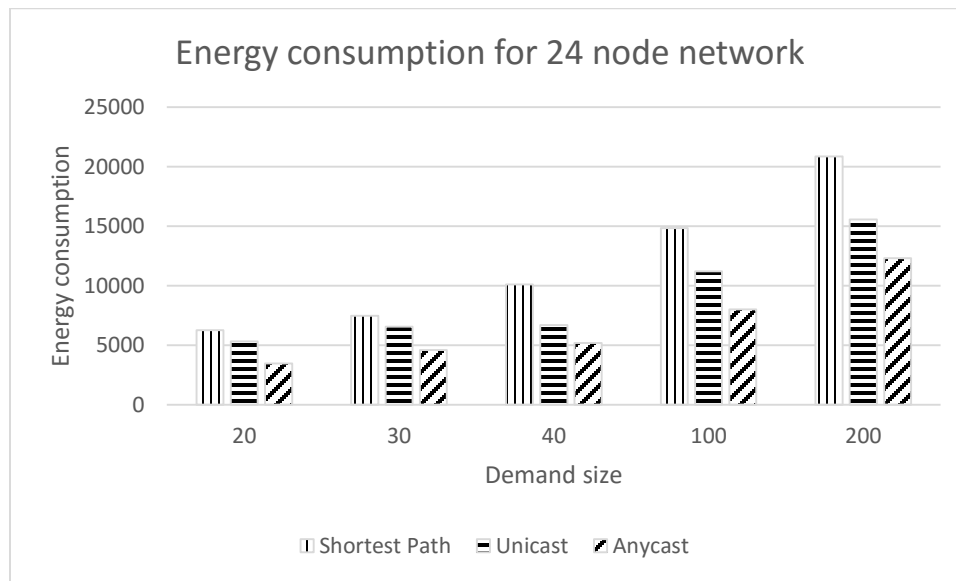

Figure 4.9 Comparison of energy consumption for 24-node network

4.2.3 Comparison of path-length and demand size

As the network and demand size increases, the number of resources required to satisfy all the demand also increases. Figure 4.10 shows the total path length of all the demands, for different demand set sizes in the 11-node topology. Clearly, the total path length increases with increase in the demand size, as expected. The shortest path approach always selects the shortest route and hence has the least total path length. Our Tabu search approaches (both unicast and anycast) often select longer routes that result in lower energy consumption. So, the trade-off for reducing energy consumption is more resource usage in terms of available channels on fiber links. Figures 4.11 and 4.12 show the corresponding results for the 14-node and 24-node networks respectively, which follow a similar pattern.

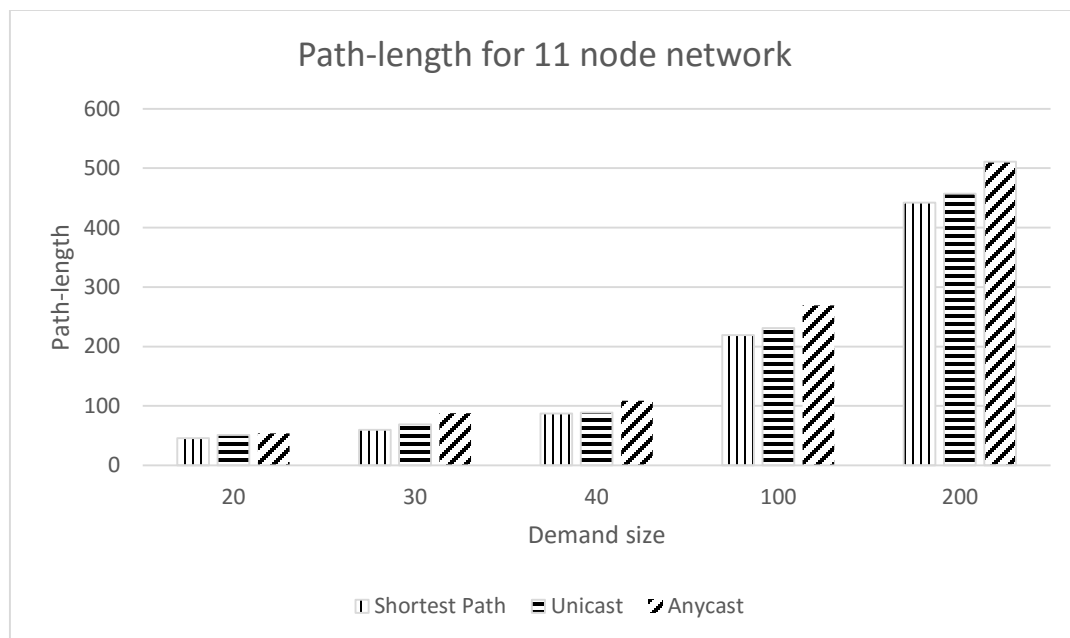

Figure 4.10 Comparison of path-length for 11-node network

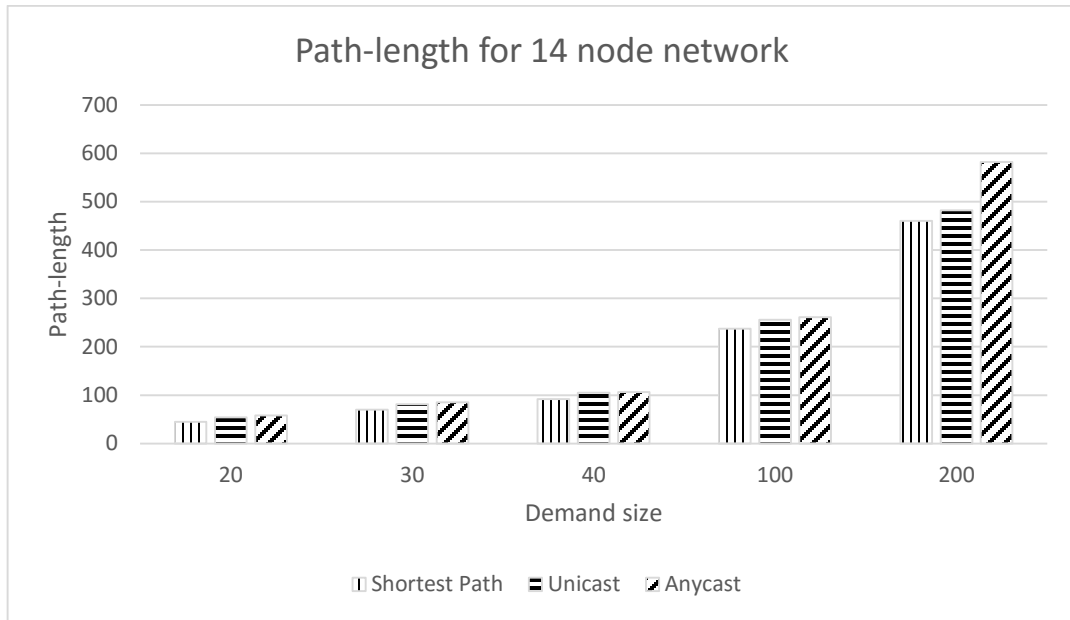

Figure 4.11 Comparison of path-length for 14-node network

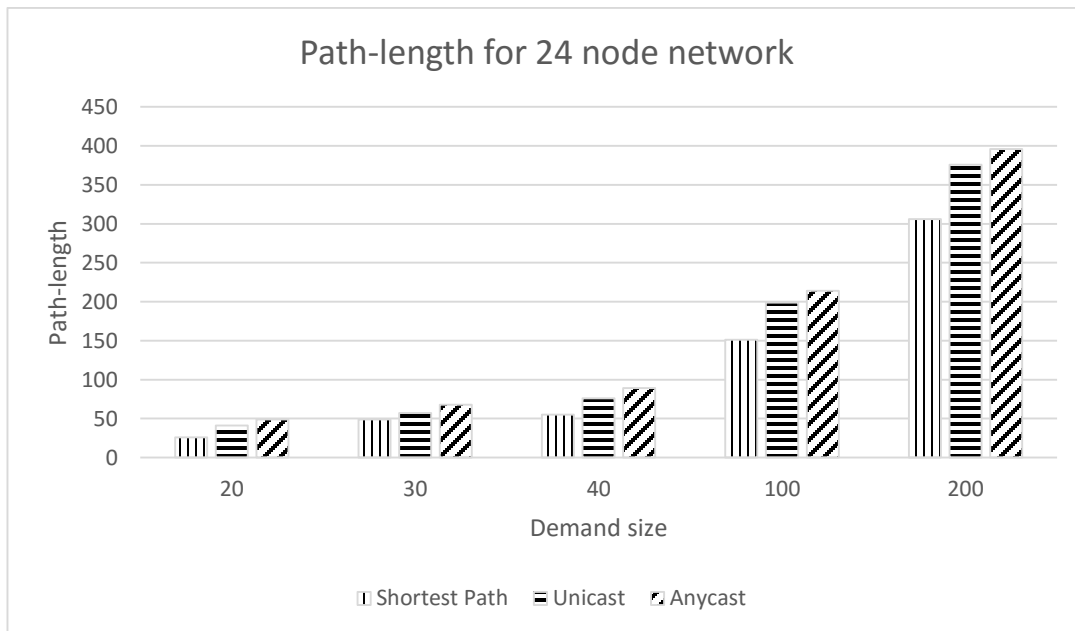

Figure 4.12 Comparison of path-length for 24-node network

CHAPTER 5

CONCLUSION AND FUTURE WORK

5.1 Conclusion

There is a need for energy efficient routing scheme due to increasing energy consumption by high bandwidth applications over the internet. In this work we have presented a new approach towards energy aware RWA, which performs efficient routing over optical grid networks for all the demands for both unicast and anycast routing. To best of our knowledge, this is the first work to use Tabu search heuristic along with anycast principle reduce overall energy consumption of optical grid networks. The main objective of our work is to minimize the overall energy consumption of the network by minimizing the number of components being used in a network. This is achieved by turning of *inactive* network components and using the network components already in use to satisfy the demands for a network. We ran our simulations on several well-known network topologies, and with different demand sets. Our approach exhibited a significant reduction in amount of energy consumption by reducing the number of *active* network components required to satisfy the demands. In order to validate our experiments we compared our approach with the widely used shortest-path routing approach. Results indicate that our approach consistently outperforms the shortest path approach with average improvements of 20% - 30%.

5.2 Future work

There is an increasing popularity in grid computing due to its use in high performance computing applications; this requires an efficient way of resource allocation and high bandwidth for proficient functioning [8]. Due to the distributive nature of optical grid network, it's essential to ensure that they are fault tolerant for efficient routing of traffic flow through the network. In our work we have only considered fault-free networks; in case, if any link or the network node fails, traffic needs to be rerouted promptly and efficiently. A promising direction to our future work can be developing fault tolerance strategies and an extension to our algorithm which work in collaboration with these strategies.

BIBLIOGRAPHY/REFERENCES

1. Koomey, J.G., Berard, S., Sanchez, M. and Wong, H., 2011. Implications of historical trends in the electrical efficiency of computing. *Annals of the History of Computing, IEEE*, 33(3), pp.46-54.
2. Aebischer, B. and Hilty, L.M., 2015. The energy demand of ICT: a historical perspective and current methodological challenges. In *ICT Innovations for Sustainability* (pp. 71-103). Springer International Publishing.
3. YAFFE, P., STUCKEY, J., ANDERSEN, E., SAHA, G.K., AN, B. and YAFEE, P., The impact of information technology on energy consumption and carbon emissions.
4. Jones, S.S., 2004. *The Basics of Telecommunications*. Intl. Engineering Consortiu.
5. https://en.wikipedia.org/wiki/Optical_networking [Last accessed on: 02/18/2016]
6. <http://www.thefoa.org/tech/ref/basic/fiber.html> [Last accessed on: 02/18/2016]
7. Pereira, T., Rusinkiewicz, S. and Matusik, W., 2014. Computational light routing: 3d printed optical fibers for sensing and display. *ACM Transactions on Graphics (TOG)*, 33(3), p.24.
8. Bandyopadhyay, S., 2007. *Dissemination of Information in Optical Networks:: From Technology to Algorithms*. Springer Science & Business Media.
9. Rouskas, G.N., 2003. Routing and wavelength assignment in optical WDM networks. *Encyclopedia of Telecommunications*.
10. https://en.wikipedia.org/wiki/Optical_amplifier#Doped_fibre_amplifiers [Last accessed on: 02/18/2016]

11. <https://en.wikipedia.org/wiki/Transceiver> [Last accessed on: 02/18/2016]
12. <https://fiberopticsof.wordpress.com/tag/optical-transceiver/> [Last accessed on: 02/18/2016]
13. [https://en.wikipedia.org/wiki/Router_\(computing\)](https://en.wikipedia.org/wiki/Router_(computing)) [Last accessed on: 02/18/2016]
14. https://en.wikipedia.org/wiki/Optical_cross-connect [Last accessed on: 02/18/2016]
15. De Leenheer, M., Develder, C., Stevens, T., Dhoedt, B., Pickavet, M. and Demeester, P., 2007, September. Design and control of optical grid networks. In *Broadband Communications, Networks and Systems, 2007. BROADNETS 2007. Fourth International Conference on* (pp. 107-115). IEEE.
16. Buysse, J., Cavdar, C., De Leenheer, M., Dhoedt, B. and Develder, C., 2011, November. Improving energy efficiency in optical cloud networks by exploiting anycast routing. In *Asia Communications and Photonics Conference and Exhibition* (p. 83100X). Optical Society of America.
17. Coiro, A., Listanti, M., Valenti, A. and Matera, F., 2011. Power-aware routing and wavelength assignment in multi-fiber optical networks. *Journal of Optical Communications and Networking*, 3(11), pp.816-829.
18. Tafani, D., Kantarci, B., Mouftah, H.T., McArdle, C. and Barry, L.P., 2012, December. Distributed management of energy-efficient lightpaths for computational grids. In *Global Communications Conference (GLOBECOM), 2012 IEEE* (pp. 2924-2929). IEEE.

19. Kantarci, B. and Mouftah, H.T., 2011, December. Energy-efficient cloud services over wavelength-routed optical transport networks. In *Global Telecommunications Conference (GLOBECOM 2011), 2011 IEEE* (pp. 1-5). IEEE.
20. Chen, Y. and Jaekel, A., 2013, June. Energy optimization in optical grids through anycasting. In *Communications (ICC), 2013 IEEE International Conference on* (pp. 3835-3839). IEEE.
21. Green, P., 2001. Progress in optical networking. *Communications Magazine, IEEE*, 39(1), pp.54-61.
22. <http://opticalengineering.spiedigitallibrary.org/article.aspx?articleid=1077128>
[Last accessed on 03/28/2016]
23. <http://optics.org/news/3/10/43> [Last accessed on 01/25/2016]
24. Kodakanchi, A., 2015. Energy aware routing in optical grid networks.
25. http://www.cisco.com/web/about/ac123/ac147/archived_issues/ipj_11-3/113_gmpls.html [Last accessed on 01/25/2016]
26. Selman, Bart, and Carla P. Gomes. "Hill-climbing Search." *Encyclopedia of Cognitive Science* (2006).
27. Mills, David L., and Hans-Werner Braun. "The NSFNET backbone network." In *ACM SIGCOMM Computer Communication Review*, vol. 17, no. 5, pp. 191-196. ACM, 1987.
28. Routing and Wavelength Assignment in Optical WDM Networks George N. Rouskas Department of Computer Science
29. Hashimoto, M. and Miura, K., 2012. Layer-Wise Topology Design for Cost Effective IP-Optical Networks.

30. Yang, H., Zhang, J., Ji, Y., Tian, R., Han, J. and Lee, Y., 2015. Performance evaluation of multi-stratum resources integration based on network function virtualization in software defined elastic data center optical interconnect. *Optics express*, 23(24), pp.31192-31205.
31. Andrei, D., Yen, H.H., Tornatore, M., Martel, C.U. and Mukherjee, B., 2009. Integrated provisioning of sliding scheduled services over WDM optical networks [Invited]. *Journal of Optical Communications and Networking*, 1(2), pp.A94-A105.

VITA AUCTORIS

NAME: Jay Raichandani

PLACE OF BIRTH: Ahmedabad, India

YEAR OF BIRTH: 1992

EDUCATION: St. Xavier's High School, Ahmedabad India, 2010
Gujarat Technological University, Gujarat, India
B.Eng. Computer Engineering 2014
University of Windsor, Windsor, Ontario
MSc Computer Science 2016